



... more than pipes



FV THERM



FV ENERGEO



FV AQUA



FV INFRA

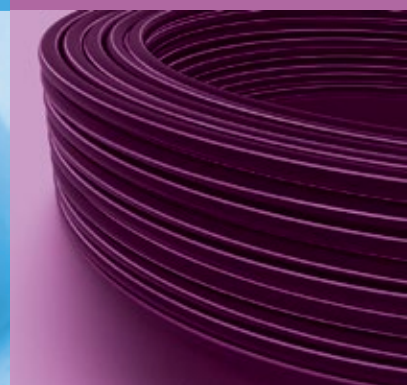

WWW.FV-PLAST.CZ



Dear business friends,

we are pleased to introduce a new portfolio of products of the company FV - Plast, a.s.

Our company celebrated 30 years since its founding – and this anniversary caught us in a good form. In the course of past years, our company achieved a significant growth in sales. We managed to consolidate our strong position on the Czech market and strengthen it significantly abroad, where 70 % of our production is directed. It affirms the rightness of our philosophy, focused on systemic and innovative solutions, quality, helpful customer service and building long-term partnerships with our foreign distributors.

FV - Plast, a.s. has always built on reliability which is crucial both for implementation companies and end customers. As a matter of principle, our company therefore includes in its portfolio only the technologies that have proven to be effective in practice. Reliability is closely connected to the emphasis which we place on quality. We buy Input raw materials strictly from renowned European suppliers and we constantly supervise our products in our own laboratory, in which we have invested more than 1,6 mil EUR.

The portfolio of FV - Plast, a.s. can be divided into four systemic groups:

- FV AQUA a system for complete water and heating distribution solutions in residential industrial development
- FV THERM a system for underfloor heating and cooling
- FV ENERGEO a systemic solution for a primary section of geothermal heat sources
- FV INFRA piping for infrastructure distributions

Products of the company FV - Plast, a.s. are certified in EU and in a whole range of other countries, such as Russia, SAE.

We are looking forward to our cooperation!

EXPLANATORY NOTES FOR GRAPHICAL SYMBOLS

Dimension	Unit	Amount in a large package	Amount in a small package	kg/unit*3	dm³/unit

Potable water	Heating, Cooling	Pools	Chemical industry	Marine architecture	Infrastructure	Industrial cooling	Service water	Geothermics

# ●		Gray
# ●		Green
# ●*1		White

*1 White pipes and fittings are only to order.

*2 Actual weight may vary within the tolerance specified in the relevant standards.

*3 Print errors are reserved.



CONTENTS

FV AQUA

Pipes for polyfusion welding	14
Plastic Fittings.....	22
Combination Fittings.....	30
Closing Fittings	38
FV PP-RCT fittings for but welding.....	42
Tools suitable for FV AQUA PPR and PP-RCT	48
Assembly instructions for FV AQUA PPR and PP-RCT	57
FV MULTIPIPES	64
FV M-PRESS brass press fittings.....	66
FV P-PRESS plastic press fittings.....	74
Tools and accessories for FV MULTIPIPES	78
Assembly instructions for connecting of pipes with pipe fittings FV M-PRESS and FV P-PRESS.....	80
Accessories	82

FV THERM

System pipes for heating	90
System plates	91
Manifold	93
Mixing sets	95
Valves and thermometers	95
Boxes.....	96
Accessories	96
Control	98
Joins	99
Accessories	100
Assembly instructions for underfloor heating system.....	102
Dry system assembly instructions.....	107

FV KLIMA

System cooling pipes.....	112
System units	112
Manifolds	113
Fittings and accessories	115
Regulation.....	116
Accessories	118
Installation instructions for cooling system.....	119

FV ENERGEO

Manifold Shafts	122
Manifold boxes.....	124
Manifold plain.....	124
Accessories to Distributor Wells	125
Fittings	125
Probes	127
Pipes for horizontal collector.....	129
Tools	130
Assembly instruction for FV ENERGEO	131

FV INFRA

FV INFRA pipes.....	134
Assembly instruction for FV INFRA	136
Index.....	138

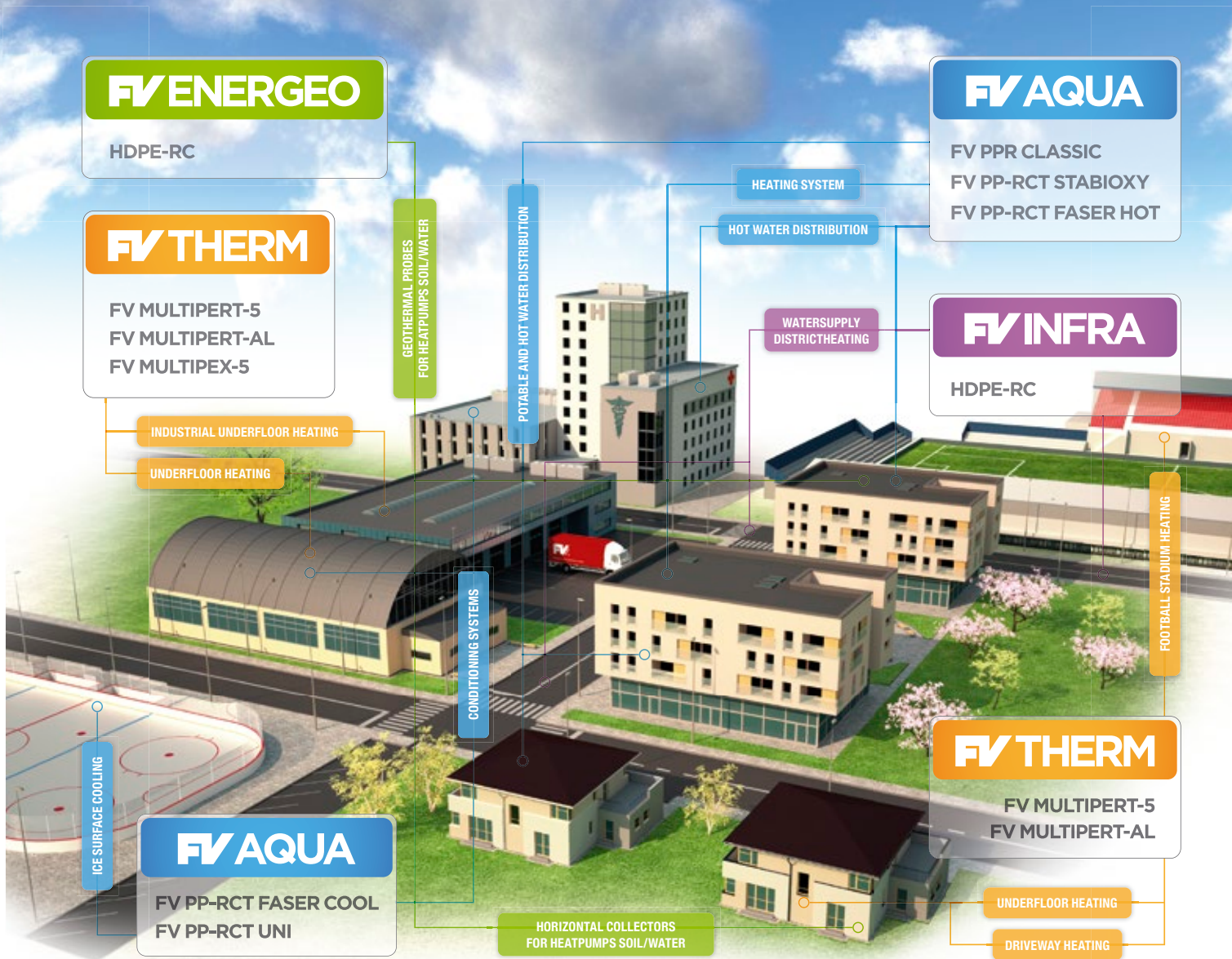

FV PLAST: MORE THAN PIPES

USE OF FV ELEMENTS

		Potable water	Air conditioning, cooling water	Hot water	Underfloor heating	Low temperature heating	High temperature heating	Preasurized air	Probes and horizontal collectors	Watersupply and connections	Cooling
FV AQUA	FV PPR CLASSIC S2,5 SDR6 (PN 20)		●	●	●	●		●			
	FV PPR FASER S2,5 SDR6 (PN 20)	●		●		●	●	●			
	FV PP-RCT UNI	●●	●	●	●	●		●			
	FV PP-RCT HOT	●		●●	●	●		●			
	FV PP-RCT FASER COOL	●	●●	●				●			
	FV PP-RCT FASER HOT			●●	●●	●●	●	●			
	FV PP-RCT STABIOXY			●	●	●	●●				
	FV MULTIPERT-AL	●	●	●	●	●	●				
	Fittings FV PPR and FV PP-RCT	●●	●●	●●		●●	●●	●			
	Fittings FV P-PRESS	●●	●●	●●	●●	●●	●				
	Fittings FV M-PRESS	●	●	●●	●●	●●	●●				
FV THERM	FV MULTIPERT-5	●	●	●	●	●	●●				
	FV MULTIPEX-5	●	●	●	●	●	●				
	FV MULTIPERT-AL	●	●	●	●	●	●				
FV KLIMA	FV COOLING PE-RT										●
	FV COOLING PB										●
FV ENERGO	FV ENERGO GH								●●		
	FV ENERGO CP								●●		
FV INFRA	FV HDPE									●	
	FV HDPE RC									●	

Explanations: ● Suitable application area
●● Priority application area

FV PP-RCT

A NEW GENERATION OF DISTRIBUTIONS

A new generation of FV PP-RCT pipes utilizes superb properties of the PP-RCT material in smooth wall and multi-layer pipes. Compared to the PPR pipes, the PP-RCT material enables to achieve the same or better pressure and thermal endurance with lesser thickness.

ADVANTAGES:

- **a flow cross-section is higher by 20 % compared to PPR pipes**
- **a proven way of connecting by polyfusion welding as in the case of PPR**
- **a higher range of working temperatures for a given application "HOT" or "COOL"**
- **a third as high thermal expansivity as in the case of PPR pipes (in the case of PP-RCT FASER and STABIOXY)**
- **a lifespan of more than 50 years**

FV PP-RCT pipes come in 5 modifications according to the purpose:

- **FV PP-RCT HOT**
Suitable for hot water distributions.
For applications between 20 °C/2,0 MPa - 70 °C/1,0 MPa
- **FV PP-RCT FASER HOT** with glass fibers
Suitable for hot water and heating distributions.
For applications between 20 °C/2,0 MPa-70 °C/1,0 MPa with maximum diameter of D=125 and 20 °C/1,6 MPa-70 °C/0,8 MPa for diameters D=160 and higher
- **FV PP-RCT STABIOXY** with a compact Al-oxygen barrier.
Suitable for high-temperature heating distributions
For applications up to 70 °C/1,0 MPa - 90 °C/0,8 MPa
- **FV PP-RCT UNI**
A universal piping for water and air distributions.
For applications up to 20 °C/1,6 MPa-60 °C/0,8 MPa
- **FV PP-RCT FASER COOL** with glass fibers.
Suitable for cold water and air distributions.
20 °C/1,6 MPa-70 °C/0,8 MPa with maximum diameter of D=125
and 20 °C/1,0 MPa-70°C/0,5 MPa for diameters D=160 and higher.



... more than pipes

WWW.FV-PLAST.CZ



FV EVOLUTION

CLASSIC PN16	▶	FV PP-RCT UNI
CLASSIC PN20	▶	FV PP-RCT HOT
FASER PN16	▶	FV PP-RCT FASER COOL
FASER PN20	▶	FV PP-RCT FASER HOT

FV AQUA

FV ENERGEO

A SYSTEM FOR UTILIZATION OF GEOTHERMAL ENERGY

FV ENERGEO is a compact system of components for solutions of primary circuits of heat pumps utilizing geothermal energy.

FV ENERGEO = ALL KEY COMPONENTS UNDER A SINGLE BRAND:

- Geothermal probes and horizontal collectors
- All components of highly resilient HDPE 100 RC
- Manifolds shafts and cases from 2 to 30 circuits
- Connecting components

The whole FV ENERGEO system is designed in such a way that it is reliable under extreme conditions. The elements are resistant to high pressure, freeze and corrosion. All the components are manufactured solely from high-quality materials under constant supervision and are tested beyond the norm.

Advantages of obtaining geothermal energy with FV ENERGEO:

- High quality and long lifespan of the components
- Reliability of the probes and collectors guaranteed thanks to the long-time experience in the field of pressure distributions
- Technical consulting for special solutions
- All the components are quickly available





FV ENERGEО CP HDPE 100 RC

HDPE-RC pipe for construction
of horizontal collectors of heat pumps

LIFE OF MORE THAN 100 YEARS

BACKFILL WITH EXCAVATED MATERIAL WITH GRAIN UP TO 250 mm

COILS UP TO 300 m



FV
PLAST®





PIPES FOR POLYFUSION WELDING

FV PP-RCT UNI

System: **FV AQUA**
 Material: PP-RCT
 Standard: ČSN EN ISO 15874, DIN 8077, DIN 8078
 Details: Suitable for water distribution to 60 °C
 and compressed air For application in systems
 to 20 °C/1,6 MPa - 60 °C/0,8 MPa.

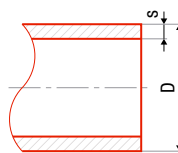

Ø x L	⊕	⊞	⊞	⊞	dm ²	# ●	# ●	# ● ^{*1}	D [mm]	s [mm]	SDR (S)	l [m]	
16 x 2,2	m	160			0,095	0,28	AA110016004	BA110016004		16	2,2	7,4 (3,2)	4
20 x 2,3	m	100			0,127	0,44	AA110020004	BA110020004		20	2,3	9 (4)	4
25 x 2,8	m	60			0,191	0,73	AA110025004	BA110025004		25	2,8	9 (4)	4
32 x 2,9	m	40			0,261	1,10	AA110032004	BA110032004		32	2,9	11 (5)	4
40 x 3,7	m	24			0,412	1,83	AA110040004	BA110040004		40	3,7	11 (5)	4
50 x 4,6	m	16			0,638	2,75	AA110050004	BA110050004		50	4,6	11 (5)	4
63 x 5,8	m	12			1,010	4,07	AA110063004	BA110063004		63	5,8	11 (5)	4
75 x 6,8	m	8			1,410	5,50	AA110075004	BA110075004		75	6,8	11 (5)	4
90 x 8,2	m	4			2,030	9,17	AA110090004	BA110090004		90	8,2	11 (5)	4
110 x 10	m	4			3,010	10,31	AA110110004	BA110110004		110	10,0	11 (5)	4
125 x 11,4	m	4			3,910	12,27		BA110125004		125	11,4	11 (5)	4
160 x 14,6	m	4			6,380	20,10		BA110160004		160	14,6	11 (5)	4
200 x 18,2	m	4			9,950	31,40		BA110200004		200	18,2	11 (5)	4
250 x 22,7	m	4			15,500	49,06		BA110250004		250	22,7	11 (5)	4

FV PP-RCT FASER COOL

System: **FV AQUA**
 Material: PP-RCT
 Standard: ČSN EN ISO 15874, DIN 8077, DIN 8078,
 DIN 16962, DIN EN ISO 15874
 Details: Suitable for cold water distribution and compressed
 air for application in systems 20 °C/1,6 MPa - 70 °C/0,8 MPa
 to D=125 and 20 °C/1,0 MPa - 70 °C/0,5 MPa to D=160 even
 larger.

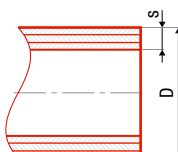

Ø x L	⊕	⊞	⊞	⊞	dm ²	# ●	# ●	# ● ^{*1}	D [mm]	s [mm]	SDR (S)	l [m]	
40 x 3,7	m	24			0,439	1,83	AA111040004	BA111040004		40	3,7	11 (5)	4
50 x 4,6	m	16			0,678	2,75	AA111050004	BA111050004		50	4,6	11 (5)	4
63 x 5,8	m	12			0,995	4,07	AA111063004	BA111063004		63	5,8	11 (5)	4
75 x 6,8	m	8			1,419	5,50	AA111075004	BA111075004		75	6,8	11 (5)	4
90 x 8,2	m	4			2,039	9,17	AA111090004	BA111090004		90	8,2	11 (5)	4
110 x 10,0	m	4			3,031	10,31	AA111110004	BA111110004		110	10,0	11 (5)	4
125 x 11,4	m	4			3,760	12,27		BA111125004		125	11,4	11 (5)	4
160 x 9,5	m	4			4,635	20,10		BA111160004		160	9,5	17 (8)	4
200 x 11,9	m	4			7,321	31,40		BA111200004		200	11,9	17 (8)	4
250 x 14,8	m	4			11,065	49,06		BA111250004		250	14,8	17 (8)	4
125 x 11,4	m	6			3,760	12,27		BA111125006		125	11,4	11 (5)	6
160 x 9,5	m	6			4,635	20,10		BA111160006		160	9,5	17 (8)	6
200 x 11,9	m	6			7,321	31,40		BA111200006		200	11,9	17 (8)	6
250 x 14,8	m	6			11,065	49,06		BA111250006		250	14,8	17 (8)	6

FV PP-RCT HOT

System: **FV AQUA**
 Material: PP-RCT
 Standard: ČSN EN ISO 15874, DIN 8077, DIN 8078
 Details: Suitable for hot water distribution. For application in systems 20 °C/2,0 MPa - 70 °C/1,0 MPa.

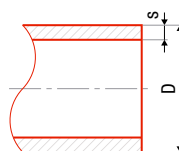

□	⊕	⊞	⊞	⊞	⊞	# ●	# ●	# ●*1	D [mm]	s [mm]	SDR (S)	l [m]	
20 × 2,8	m	100			0,148	0,44	AA112020004	BA112020004		20	2,8	7,4 (3,2)	4
25 × 3,5	m	60			0,230	0,73	AA112025004	BA112025004		25	3,5	7,4 (3,2)	4
32 × 4,4	m	40			0,370	1,10	AA112032004	BA112032004		32	4,4	7,4 (3,2)	4
40 × 5,5	m	24			0,575	1,83	AA112040004	BA112040004		40	5,5	7,4 (3,2)	4
50 × 6,9	m	16			0,896	2,75	AA112050004	BA112050004		50	6,9	7,4 (3,2)	4
63 × 8,6	m	12			1,410	4,07	AA112063004	BA112063004		63	8,6	7,4 (3,2)	4
75 × 10,3	m	8			2,010	5,50	AA112075004	BA112075004		75	10,3	7,4 (3,2)	4
90 × 12,3	m	4			2,870	9,17	AA112090004	BA112090004		90	12,3	7,4 (3,2)	4
110 × 15,1	m	4			4,300	10,31	AA112110004	BA112110004		110	15,1	7,4 (3,2)	4
125 × 17,1	m	4			5,530	12,27		BA112125004		125	17,1	7,4 (3,2)	4

FV PP-RCT FASER HOT

System: **FV AQUA**
 Material: PP-RCT
 Standard: ČSN EN ISO 15874, DIN 8077, DIN 8078, DIN 16962, DIN EN ISO 15874
 Details: Suitable for hot water distribution. For application in systems 20 °C/2,0 MPa - 70 °C/1,0 MPa to D=125 and 20 °C/1,6 MPa - 70 °C/0,8 MPa to D=160 even larger.

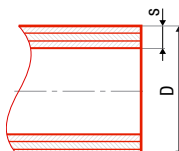

□	⊕	⊞	⊞	⊞	⊞	# ●	# ●	# ●*1	D [mm]	s [mm]	SDR (S)	l [m]	
20 × 2,8	m	100			0,151	0,44	AA113020004	BA113020004		20	2,8	7,4 (3,2)	4
25 × 3,5	m	60			0,232	0,73	AA113025004	BA113025004		25	3,5	7,4 (3,2)	4
32 × 3,6	m	40			0,340	1,10	AA113032004	BA113032004		32	3,6	9 (4)	4
40 × 4,5	m	24			0,513	1,83	AA113040004	BA113040004		40	4,5	9 (4)	4
50 × 5,6	m	16			0,746	2,75	AA113050004	BA113050004		50	5,6	9 (4)	4
63 × 7,1	m	12			1,190	4,07	AA113063004	BA113063004		63	7,1	9 (4)	4
75 × 8,4	m	8			1,700	5,50	AA113075004	BA113075004		75	8,4	9 (4)	4
90 × 10,1	m	4			2,400	9,17	AA113090004	BA113090004		90	10,1	9 (4)	4
110 × 12,3	m	4			3,400	10,31	AA113110004	BA113110004		110	12,3	9 (4)	4
125 × 14,0	m	4			4,480	12,27		BA113125004		125	14,0	9 (4)	4
160 × 14,6	m	4			6,775	20,10		BA113160004		160	14,6	11 (5)	4
200 × 18,2	m	4			10,640	31,40		BA113200004		200	18,2	11 (5)	4
250 × 22,7	m	4			16,610	49,06		BA113250004		250	22,7	11 (5)	4
125 × 14,0	m	6			4,480	12,27		BA113125006		125	14,0	9 (4)	6
160 × 14,6	m	6			6,775	20,10		BA113160006		160	14,6	11 (5)	6
200 × 18,2	m	6			10,640	31,40		BA113200006		200	18,2	11 (5)	6
250 × 22,7	m	6			16,610	49,06		BA113250006		250	22,7	11 (5)	6

FV PP-RCT STABIOXY

System: **FV AQUA**
 Material: PP-RCT/Al/PP-R
 Standard: ČSN EN ISO 21003, DIN 4726
 Details: Suitable for radiator heating. For application in systems 70 °C/1,0 MPa - 90 °C/0,8 MPa.

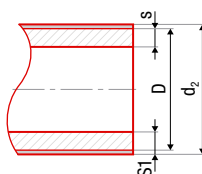

□	⊕	⊞	⊞	⊞	⊞	# ●	# ●	# ●*1	D [mm]	d ₂ [mm]	s [mm]	SDR (S)	l [m]	
20 × 2,8	m	100			0,21	0,44	AA114020004	BA114020004		20	22,2	2,8	7,4 (3,2)	4
25 × 2,8	m	60			0,31	0,73	AA114025004	BA114025004		25	27,2	2,8	9 (4)	4
32 × 3,6	m	40			0,47	1,10	AA114032004	BA114032004		32	34,2	3,6	9 (4)	4
40 × 4,5	m	24			0,69	1,83	AA114040004	BA114040004		40	42,2	4,5	9 (4)	4
50 × 5,6	m	16			1,04	2,75	AA114050004	BA114050004		50	52,3	5,6	9 (4)	4
63 × 7,1	m	12			1,57	4,07	AA114063004	BA114063004		63	65,4	7,1	9 (4)	4
75 × 8,4	m	8			2,25	5,50	AA114075004	BA114075004		75	77,5	8,4	9 (4)	4
90 × 10,1	m	4			3,37	9,17	AA114090004	BA114090004		90	93	10,1	9 (4)	4
110 × 12,3	m	4			5,00	10,31	AA114110004	BA114110004		110	113,6	12,3	9 (4)	4

FV PPR CLASSIC S2,5 SDR6 (PN 20) 4m

System: **FV AQUA**

Material: PPR

Standard: ČSN EN ISO 15874, DIN 8077, DIN 8078

Details: A 4-m pipe from among the highest pressure range, suitable for hot water distribution systems, applications in high-rise buildings, apartment and panel buildings.

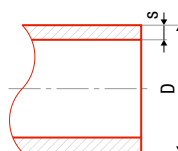

DN	PN	mm	mm	mm	mm ²	# ●	# ●	# ● ^{*1}	D [mm]	s [mm]	l [m]
16 × 2,7	m	160		0,11	0,28	AA101016004	BA101016004	WA101016004	16	2,70	4
20 × 3,4	m	100		0,17	0,44	AA101020004	BA101020004	WA101020004	20	3,40	4
25 × 4,2	m	60		0,27	0,73	AA101025004	BA101025004	WA101025004	25	4,20	4
32 × 5,4	m	40		0,43	1,10	AA101032004	BA101032004	WA101032004	32	5,40	4
40 × 6,7	m	24		0,67	1,83	AA101040004	BA101040004	WA101040004	40	6,70	4
50 × 8,3	m	16		1,00	2,75	AA101050004	BA101050004	WA101050004	50	8,30	4
63 × 10,5	m	12		1,65	4,07	AA101063004	BA101063004	WA101063004	63	10,50	4
75 × 12,5	m	8		2,34	5,50	AA101075004	BA101075004	WA101075004	75	12,50	4
90 × 15	m	4		3,36	9,17	AA101090004	BA101090004	WA101090004	90	15,00	4
110 × 18,3	m	4		5,01	10,31	AA101110004	BA101110004	WA101110004	110	18,30	4

FV PPR CLASSIC S2,5 SDR6 (PN 20) 3m

System: **FV AQUA**

Material: PPR

Standard: ČSN EN ISO 15874, DIN 8077, DIN 8078

Details: A 3-m pipe from among the highest pressure range, suitable for hot water distribution systems, applications in high-rise buildings, apartment and panel buildings.

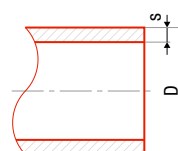

DN	PN	mm	mm	mm	mm ²	# ●	# ●	# ● ^{*1}	D [mm]	s [mm]	l [m]
16 × 2,7	m	120		0,11	0,28	AA101016003	BA101016003	WA101016003	16	2,70	3
20 × 3,4	m	75		0,17	0,44	AA101020003	BA101020003	WA101020003	20	3,40	3
25 × 4,2	m	45		0,27	0,73	AA101025003	BA101025003	WA101025003	25	4,20	3
32 × 5,4	m	30		0,43	1,10	AA101032003	BA101032003	WA101032003	32	5,40	3
40 × 6,7	m	18		0,67	1,83	AA101040003	BA101040003	WA101040003	40	6,70	3
50 × 8,3	m	12		1,00	2,75	AA101050003	BA101050003	WA101050003	50	8,30	3
63 × 10,5	m	9		1,65	4,07	AA101063003	BA101063003	WA101063003	63	10,50	3

FV PPR CLASSIC - PIPE IN COIL

System: **FV AQUA**

Material: PPR

Standard: ČSN EN ISO 15874, DIN 8077, DIN 8078

Details: A pipe packed in 200-m rolls suitable for floor heating systems.

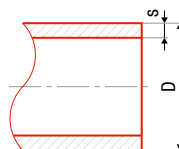

						# ●	# ●	# ● ⁺¹	D [mm]	s [mm]	l [m]
16 × 2,0	m	200		0,09	2,01	AA103016200	BA103016200	WA103016200	16	2,00	200
20 × 2,0	m	200		0,11	3,14	AA103020200	BA103020200	WA103020200	20	2,00	200
20 × 2,8	m	200		0,15	3,14	AA102020200	BA102020200	WA102020200	20	2,80	200
20 × 3,4	m	200		0,17	3,14	AA101020200	BA101020200	WA101020200	20	3,40	200

FV PPR FASER S2,5 SDR6 (PN 20) 4m

System: **FV AQUA**
 Material: PPR
 Standard: DIN 16962, DIN EN ISO 15874
 Details: A universal 4-m pipe for the most challenging drinking, hot and heating water distribution systems.

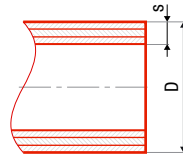

						# ●	# ●	# ● *1	D [mm]	s [mm]	l [m]
20 x 3,4	m	100		0,19	0,44	AA107020004	BA107020004	WA107020004	20	3,40	4
25 x 4,2	m	60		0,28	0,73	AA107025004	BA107025004	WA107025004	25	4,20	4
32 x 5,4	m	40		0,45	1,10	AA107032004	BA107032004	WA107032004	32	5,40	4
40 x 6,7	m	24		0,69	1,83	AA107040004	BA107040004	WA107040004	40	6,70	4
50 x 8,3	m	16		1,07	2,75	AA107050004	BA107050004	WA107050004	50	8,30	4
63 x 10,5	m	12		1,74	4,07	AA107063004	BA107063004	WA107063004	63	10,50	4
75 x 12,5	m	8		2,41	5,50	AA107075004	BA107075004	WA107075004	75	12,50	4
90 x 15,0	m	4		3,47	9,17	AA107090004	BA107090004	WA107090004	90	15,00	4
110 x 18,3	m	4		5,17	10,31	AA107110004	BA107110004	WA107110004	110	18,30	4

FV PPR FASER S2,5 SDR6 (PN 20) 3m

System: **FV AQUA**
 Material: PPR
 Standard: DIN 16962, DIN EN ISO 15874
 Details: A universal 3-m pipe for the most challenging drinking, hot and heating water distribution systems.

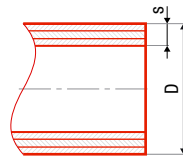

						# ●	# ●	# ● *1	D [mm]	s [mm]	l [m]
20 x 3,4	m	75		0,19	0,44	AA107020003	BA107020003	WA107020003	20	3,40	3
25 x 4,2	m	45		0,28	0,73	AA107025003	BA107025003	WA107025003	25	4,20	3
32 x 5,4	m	30		0,45	1,10	AA107032003	BA107032003	WA107032003	32	5,40	3
40 x 6,7	m	18		0,69	1,83	AA107040003	BA107040003	WA107040003	40	6,70	3
50 x 8,3	m	12		1,07	2,75	AA107050003	BA107050003	WA107050003	50	8,30	3
63 x 10,5	m	9		1,74	4,07	AA107063003	BA107063003	WA107063003	63	10,50	3

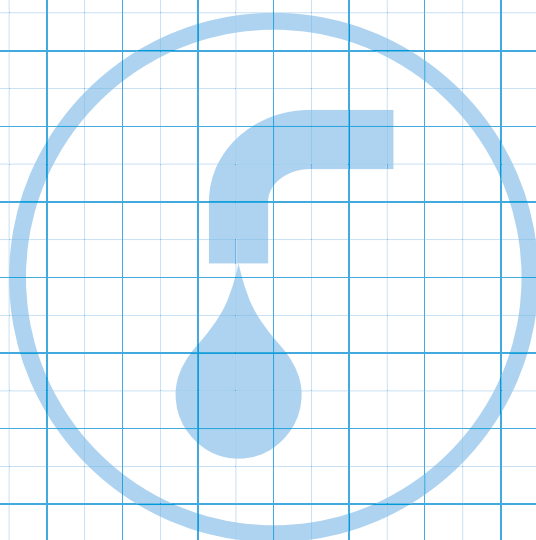





FV
PLAST®

PLASTIC FITTINGS

FV PPR compensation pipe

System: **FV AQUA**
 Material: PPR
 Standard: ČSN EN ISO 15874, DIN 8077, DIN 8078
 Details: Preventing deformations in a piping system caused by thermal expansion.

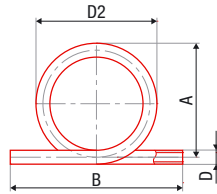

Icon	Symbol	Grid	Grid	Weight	dm ³	# ●	# ●	# ● *1	D [mm]	D2 [mm]	A [mm]	B [mm]
	pcs	10	1	0,07	1,60	AA232016000	BA232016000	WA232016000	16	188,0	180	290
	pcs	6	1	0,11	1,60	AA232020000	BA232020000	WA232020000	20	210,0	200	300
	pcs	5	1	0,21	3,20	AA232025000	BA232025000	WA232025000	25	217,5	205	370
	pcs	4	1	0,43	8,00	AA232032000	BA232032000	WA232032000	32	231,0	215	400
	pcs	2	1	0,67	8,00	AA232040000	BA232040000	WA232040000	40	295,0	275	420

FV PPR crossover

System: **FV AQUA**
 Material: PPR
 Standard: ČSN EN ISO 15874, DIN 8077, DIN 8078
 Details: For pipe crossing in case of branching, connection to a fitting.

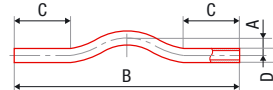

Icon	Symbol	Grid	Grid	Weight	dm ³	# ●	# ●	# ● *1	D [mm]	A [mm]	B [mm]	C [mm]
	pcs	180	1	0,03	0,24	AA233016000	BA233016000	WA233016000	16	35	380	100
	pcs	100	1	0,07	0,32	AA233020000	BA233020000	WA233020000	20	42	400	110
	pcs	50	1	0,09	0,64	AA233025000	BA233025000	WA233025000	25	30	400	100
	pcs	35	1	0,16	0,80	AA233032000	BA233032000	WA233032000	32	35	400	90
	pcs	20	1	0,33	1,60	AA233040000	BA233040000	WA233040000	40	35	400	90

FV PPR crossover with socket

System: **FV AQUA**
 Material: PPR
 Standard: ČSN EN ISO 15874, DIN 8077, DIN 8078
 Details: For pipe crossing in case of branching, connection to a pipe.

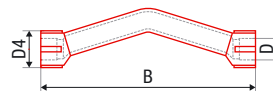

Icon	Symbol	Grid	Grid	Weight	dm ³	# ●	# ●	# ● *1	D4 [mm]	B [mm]	D [mm]
	pcs	100	1	0,07	0,24	AA246020000	BA246020000	WA246020000	31	188	20
	pcs	50	1	0,09	0,32	AA246025000	BA246025000	WA246025000	37	198	25

FV PPR crossover with socket short

System: **FV AQUA**
 Material: PPR
 Standard: ČSN EN ISO 15874, DIN 8077, DIN 8078
 Details: For pipe crossing with minimal occupation of space. The socket end saves assembly time.

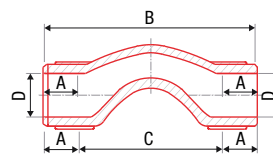

Icon	Symbol	Grid	Grid	Weight	dm ³	# ●	# ●	# ● *1	D [mm]	A [mm]	B [mm]	C [mm]
	pcs	160	1	0,029	0,117	AA246020001	BA246020001	WA246020001	20	14,5	88	59
	pcs	100	1	0,044	0,187	AA246025001	BA246025001	WA246025001	25	16	97	65

FV PPR elbow 90°

System: **FV AQUA**
 Material: PPR
 Standard: ČSN EN ISO 15874, DIN 8077, DIN 8078
 Details: A simple, reliable fitting for changing the pipeline direction.

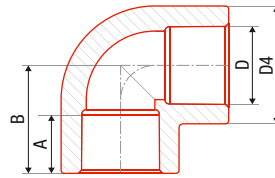

Code	Quantity	Weight	Volume	Price	Area	# ●	# ●	# ●*1	D [mm]	D4 [mm]	A [mm]	B [mm]
16	pcs	200	50	0,01	0,05	AA202016000	BA202016000	WA202016000	16	24	13,3	22,0
20	pcs	300	50	0,02	0,07	AA202020000	BA202020000	WA202020000	20	29	14,5	25,5
25	pcs	150	25	0,03	0,12	AA202025000	BA202025000	WA202025000	25	37	16,0	29,0
32	pcs	80	10	0,06	0,24	AA202032000	BA202032000	WA202032000	32	46	18,1	34,2
40	pcs	40	4	0,11	0,53	AA202040000	BA202040000	WA202040000	40	60	20,5	41,5
50	pcs	30	2	0,19	0,96	AA202050000	BA202050000	WA202050000	50	73	23,5	48,5
63	pcs	10	2	0,37	1,92	AA202063000	BA202063000	WA202063000	63	94	27,4	59,2
75	pcs	6	1	0,52	3,20	AA202075000	BA202075000	WA202075000	75	108	31,0	67,7
90	pcs	6	1	0,79	4,80	AA202090000	BA202090000	WA202090000	90	126	35,5	78,4
110	pcs	3	1	1,38	5,50	AA202110000	BA202110000	WA202110000	110	151	41,5	98,0
125	pcs	1	1	2,05	7,04	AA202125000	BA202125000	WA202125000	125	165	40	124

FV PPR elbow 90° reduced

System: **FV AQUA**
 Material: PPR
 Standard: ČSN EN ISO 15874, DIN 8077, DIN 8078
 Details: A simple, reliable fitting for changing the pipeline direction and dimension.

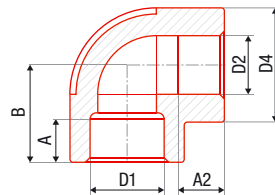

Code	Quantity	Weight	Volume	Price	Area	# ●	# ●	# ●*1	D1 [mm]	D2 [mm]	D4 [mm]	A [mm]	B [mm]
25 x 20	pcs	50	1	0,09	0,32	AA211025020	BA211025020	WA211025020	25	20	36,8	16	32,2

FV PPR elbow 45°

System: **FV AQUA**
 Material: PPR
 Standard: ČSN EN ISO 15874, DIN 8077, DIN 8078
 Details: A simple, reliable fitting for changing the pipeline direction.

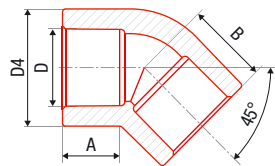

Code	Quantity	Weight	Volume	Price	Area	# ●	# ●	# ●*1	D [mm]	D4 [mm]	A [mm]	B [mm]
16	pcs	200	50	0,01	0,03	AA203016000	BA203016000	WA203016000	16	24,3	13,3	17,5
20	pcs	400	50	0,02	0,07	AA203020000	BA203020000	WA203020000	20	29,1	14,5	19,5
25	pcs	200	25	0,03	0,12	AA203025000	BA203025000	WA203025000	25	36,8	16,0	22,0
32	pcs	80	10	0,06	0,24	AA203032000	BA203032000	WA203032000	32	46,0	18,1	25,5
40	pcs	30	10	0,11	0,53	AA203040000	BA203040000	WA203040000	40	59,0	20,5	30,0
50	pcs	28	4	0,19	0,96	AA203050000	BA203050000	WA203050000	50	74,85	23,5	34,5
63	pcs	10	2	0,37	1,92	AA203063000	BA203063000	WA203063000	63	94,0	27,4	44,5
75	pcs	6	1	0,52	3,20	AA203075000	BA203075000	WA203075000	75	99,0	30,0	48,0
90	pcs	6	1	0,79	4,80	AA203090000	BA203090000	WA203090000	90	120	33,0	54,1
110	pcs	4	1	1,38	5,50	AA203110000	BA203110000	WA203110000	110	148	37,0	69,0
125	pcs	2	1	1,40	3,20	AA203125000	BA203125000	WA203125000	125	165	40,0	77,0

FV PPR elbow 90° internal / external

System: **FV AQUA**
 Material: PPR
 Standard: ČSN EN ISO 15874, DIN 8077, DIN 8078
 Details: A simple, reliable fitting for changing the pipeline direction.

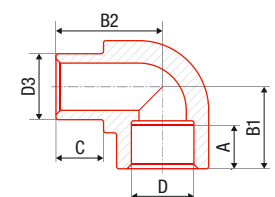

Code	Quantity	Weight	Volume	Price	Area	# ●	# ●	# ●*1	D, D3 [mm]	A [mm]	B1 [mm]	B2 [mm]	C [mm]
20	pcs	400	50	0,01	0,05	AA204020000	BA204020000	WA204020000	20	14,5	25,6	29,0	14,5
25	pcs	200	25	0,03	0,14	AA204025000	BA204025000	WA204025000	25	16,0	31,5	35,4	14,8
32	pcs	100	20	0,07	0,22	AA204032000	BA204032000	WA204032000	32	18,0	36,5	42,2	16,0

FV PPR elbow 45° internal / external

System: **FV AQUA**
 Material: PPR
 Standard: ČSN EN ISO 15874, DIN 8077, DIN 8078
 Details: A simple, reliable fitting for changing the pipeline direction.

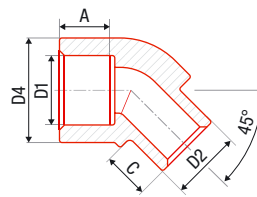

Icon	⊕	⊞	⊞	🔒	dm ²	# ●	# ●	# ● *1	D1 [mm]	D2 [mm]	D4 [mm]	A [mm]	C [mm]
16	pcs	280	20	0,010	0,04	AA205016000	BA205016000	WA205016000	16	16	24,2	13,3	12,5
20	pcs	200	20	0,020	0,07	AA205020000	BA205020000	WA205020000	20	20	29,5	14,5	14,8
25	pcs	100	10	0,026	0,07	AA205025000			25	25	36,3	18,3	17,3

FV PPR elbow 90° for wall mounting welding

System: **FV AQUA**
 Material: PPR
 Standard: ČSN EN ISO 15874, DIN 8077, DIN 8078
 Details: Fixing fitting with tap connector for mixers.

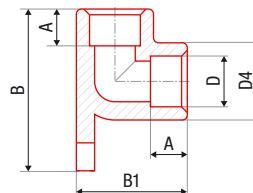

Icon	⊕	⊞	⊞	🔒	dm ²	# ●	# ●	# ● *1	D [mm]	D4 [mm]	A [mm]	B [mm]	B1 [mm]
20	pcs	60	10	0,02	0,16	AA206020000	BA206020000	WA206020000	20	30,2	14,5	48,5	43,5
25	pcs	40	10	0,04	0,32	AA206025000	BA206025000	WA206025000	25	35,3	16,0	76,2	51,0

FV PPR reduction internal / external

System: **FV AQUA**
 Material: PPR
 Standard: ČSN EN ISO 15874, DIN 8077, DIN 8078
 Details: A simple, reliable fitting for dimension change of pipeline.

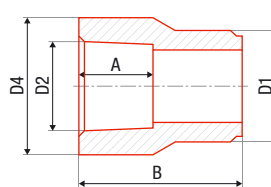

Icon	⊕	⊞	⊞	🔒	dm ²	# ●	# ●	# ● *1	D1 [mm]	D2 [mm]	D4 [mm]	A [mm]	B [mm]
20 x 16	pcs	400	50	0,01	0,02	AA210020016	BA210020016	WA210020016	20	16	24,0	13,3	28,4
25 x 16	pcs	300	50	0,01	0,03	AA210025016	BA210025016	WA210025016	25	16	30,1	13,3	31,8
25 x 20	pcs	400	50	0,01	0,05	AA210025020	BA210025020	WA210025020	25	20	30,1	14,5	34,2
32 x 20	pcs	300	10	0,03	0,13	AA210032020	BA210032020	WA210032020	32	20	33,8	14,5	35,4
32 x 25	pcs	200	10	0,03	0,12	AA210032025	BA210032025	WA210032025	32	25	36,0	16,0	38,9
40 x 20	pcs	180	10	0,02	0,13	AA210040020	BA210040020	WA210040020	40	20	40,0	14,5	41,5
40 x 25	pcs	180	10	0,03	0,16	AA210040025	BA210040025	WA210040025	40	25	37,9	16,0	43,5
40 x 32	pcs	120	10	0,04	0,24	AA210040032	BA210040032	WA210040032	40	32	47,3	18,1	50,7
50 x 32	pcs	80	10	0,05	0,27	AA210050032	BA210050032	WA210050032	50	32	50,3	18,1	50,6
50 x 40	pcs	60	10	0,05	0,30	AA210050040	BA210050040	WA210050040	50	40	60,5	20,5	49,8
63 x 32	pcs	60	10	0,07	0,32	AA210063032	BA210063032	WA210063032	63	32	48,2	18,1	43,5
63 x 40	pcs	50	10	0,08	0,40	AA210063040	BA210063040	WA210063040	63	40	59,7	20,5	52,0
63 x 50	pcs	40	10	0,12	0,60	AA210063050	BA210063050	WA210063050	63	50	74,3	23,5	62,0
75 x 40	pcs	20	5	0,12	0,60	AA210075040	BA210075040	WA210075040	75	40	93,2	20,5	64,5
75 x 50	pcs	20	5	0,12	0,80	AA210075050	BA210075050	WA210075050	75	50	93,2	23,5	57,5
75 x 63	pcs	24	2	0,21	1,37	AA210075063	BA210075063	WA210075063	75	63	93,2	27,4	72,2
90 x 63	pcs	25	1	0,24	0,98	AA210090063	BA210090063	WA210090063	90	63	94,8	27,4	70,8
90 x 75	pcs	20	1	0,27	2,40	AA210090075	BA210090075	WA210090075	90	75	106,0	31,0	73,2
110 x 75	pcs	1	1	0,30	1,32	AA210110075	BA210110075	WA210110075	110	75	125,8	30,0	64,0
110 x 90	pcs	1	1	0,50	2,80	AA210110090	BA210110090	WA210110090	110	90	125,8	35,5	91,7
125 x 110*	pcs	1	1	1,03	3,52		BA210125110		125	110	134,6	85,0	225

* Fitting 125 x110 for butt welding.

FV PPR three-way elbow

System: **FV AQUA**
 Material: PPR
 Standard: ČSN EN ISO 15874, DIN 8077, DIN 8078
 Details: A simple, reliable fitting for branching the pipeline.

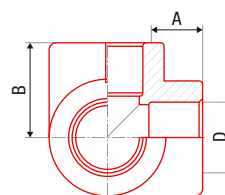

Icon	⊕	⊞	⊞	🔒	dm ²	# ●	# ●	# ● *1	D [mm]	A [mm]	B [mm]
20	pcs	50	10	0,03	0,13	AA242020000	BA242020000	WA242020000	20	14,5	26,8
25	pcs	50	10	0,04	0,17	AA242025000	BA242025000	WA242025000	25	16,0	29,5
32	pcs	20	5	0,05	0,20	AA242032000	BA242032000	WA242032000	32	18,0	35,0

FV PPR socket

System: **FV AQUA**

Material: PPR

Standard: ČSN EN ISO 15874, DIN 8077, DIN 8078

Details: A simple, reliable fitting for pipe connection.

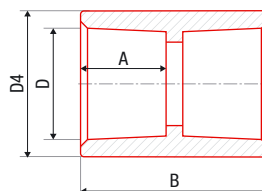

QTY	⊕	⊞	⊠	⊡	⊣	# ●	# ●	# ●*1	D [mm]	D4 [mm]	A [mm]	B [mm]
16	pcs	300	50	0,01	0,03	AA201016000	BA201016000	WA201016000	16	24,10	13,3	29,6
20	pcs	400	50	0,01	0,05	AA201020000	BA201020000	WA201020000	20	29,10	14,5	32,0
25	pcs	200	25	0,03	0,10	AA201025000	BA201025000	WA201025000	25	36,70	16,0	35,5
32	pcs	100	10	0,04	0,19	AA201032000	BA201032000	WA201032000	32	46,20	18,1	38,3
40	pcs	100	10	0,06	0,24	AA201040000	BA201040000	WA201040000	40	59,50	20,5	45,4
50	pcs	40	4	0,11	0,60	AA201050000	BA201050000	WA201050000	50	73,00	23,5	50,8
63	pcs	30	2	0,19	0,87	AA201063000	BA201063000	WA201063000	63	90,30	27,4	58,5
75	pcs	15	1	0,27	1,92	AA201075000	BA201075000	WA201075000	75	108,5	31,0	66,5
90	pcs	10	1	0,42	2,40	AA201090000	BA201090000	WA201090000	90	127,3	35,5	73,6
110	pcs	4	1	0,67	2,80	AA201110000	BA201110000	WA201110000	110	152,7	41,5	87,2
125	pcs	1	1	0,75	2,45		BA201125000		125	165,0	40,0	90,0

FV PPR reduction

System: **FV AQUA**

Material: PPR

Standard: ČSN EN ISO 15874, DIN 8077, DIN 8078

Details: A simple, reliable fitting for dimension change of pipeline.

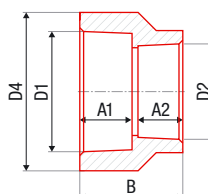

QTY	⊕	⊞	⊠	⊡	⊣	# ●	# ●	# ●*1	D1 [mm]	D2 [mm]	D4 [mm]	A1/A2 [mm]	B [mm]
20 x 16	pcs	200	50	0,01	0,05	AA209020016	BA209020016	WA209020016	20	16	29,0	14,5/13,3	33,0
25 x 20	pcs	300	50	0,02	0,11	AA209025020	BA209025020	WA209025020	25	20	36,7	16/14,5	34,3
32 x 20	pcs	180	10	0,02	0,13	AA209032020	BA209032020	WA209032020	32	20	46,3	18,1/14,5	35,0
32 x 25	pcs	150	10	0,03	0,13	AA209032025	BA209032025	WA209032025	32	25	47,1	18,1/16	38,0
40 x 32	pcs					Order kindly equivalent adaptor inner / outer 63 x 32							
50 x 40	pcs	40	4	0,09	0,60	AA209050040	BA209050040	WA209050040	50	40		23,5/20,5	47,0
63 x 50	pcs	24	2	0,17	0,80	AA209063050	BA209063050	WA209063050	63	50	93,2	27,4/23,5	54,0

FV PPR bend 90° internal / external

System: **FV AQUA**

Material: PPR

Standard: ČSN EN ISO 15874, DIN 8077, DIN 8078

Details: For change of direction with lower pressure losses.

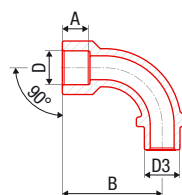

QTY	⊕	⊞	⊠	⊡	⊣	# ●	# ●	# ●*1	D [mm]	D3 [mm]	A [mm]	B [mm]
20	pcs	100	10	0,03	0,12	AA241020000			20	20	13	56

FV PPR bend 90°

System: **FV AQUA**

Material: PPR

Standard: ČSN EN ISO 15874, DIN 8077, DIN 8078

Details: For change of direction with lower pressure losses.

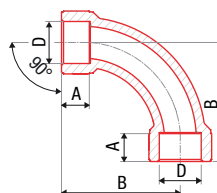

QTY	⊕	⊞	⊠	⊡	⊣	# ●	# ●	# ●*1	D [mm]	A [mm]	B [mm]
20	pcs	125	1	0,024	0,144	AA259020000	BA259020000	WA259020000	20	14,5	56
25	pcs	100	1	0,049	0,216	AA259025000	BA259025000	WA259025000	25	16	68,5
32	pcs	50	1	0,100	0,432	AA259032000	BA259032000	WA259032000	32	18	85,5
40	pcs	25	1	0,193	0,864	AA259040000	BA259040000	WA259040000	40	20,5	106

FV PPR tee

System: **FV AQUA**
 Material: PPR
 Standard: ČSN EN ISO 15874, DIN 8077, DIN 8078
 Details: A simple, reliable fitting for branching the pipeline.

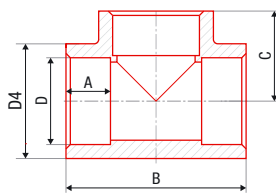

Code	Unit	100	200	Weight [kg]	Volume [dm³]	# ●	# ●	# ●*1	D [mm]	D4 [mm]	A [mm]	B [mm]	C [mm]
16	pcs	150	50	0,02	0,08	AA208016000	BA208016000	WA208016000	16	24,6	13,3	44	23,0
20	pcs	160	20	0,03	0,12	AA208020000	BA208020000	WA208020000	20	29,0	14,5	51	25,5
25	pcs	120	20	0,04	0,24	AA208025000	BA208025000	WA208025000	25	36,5	16,0	59	31,4
32	pcs	60	10	0,08	0,40	AA208032000	BA208032000	WA208032000	32	45,3	18,1	71	35,0
40	pcs	48	4	0,13	0,96	AA208040000	BA208040000	WA208040000	40	58,0	20,5	83	41,5
50	pcs	22	2	0,25	1,60	AA208050000	BA208050000	WA208050000	50	74,0	23,5	99	49,0
63	pcs	9	1	0,46	2,74	AA208063000	BA208063000	WA208063000	63	93,0	27,4	120	60,0
75	pcs	6	1	0,62	3,20	AA208075000	BA208075000	WA208075000	75	108,0	31,0	137	68,5
90	pcs	5	1	0,99	4,80	AA208090000	BA208090000	WA208090000	90	128,5	35,5	163	80,5
110	pcs	2	1	1,78	5,50	AA208110000	BA208110000	WA208110000	110	152,6	41,5	186	97,0
125	pcs	1	1	2,51	8,45		BA208125000		125	165,0	40,0	248	124

FV PPR tee reduced

System: **FV AQUA**
 Material: PPR
 Standard: ČSN EN ISO 15874, DIN 8077, DIN 8078
 Details: A simple, reliable fitting for branching the pipeline.

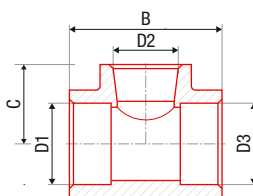

Code	Unit	100	200	Weight [kg]	Volume [dm³]	# ●	# ●	# ●*1	D1 [mm]	D2 [mm]	D3 [mm]	B [mm]	C [mm]
20 x 16 x 20	pcs	100	10	0,03	0,10	AA212020016	BA212020016	WA212020016	20	16	20	52,2	27,4
20 x 25 x 20	pcs	100	20	0,03	0,24	AA212020025	BA212020025	WA212020025	20	25	20	64,0	27,0
25 x 20 x 20	pcs	50	10	0,05	0,24	AA212025021	BA212025021	WA212025021	25	20	20	58,8	31,6
25 x 20 x 25	pcs	120	20	0,04	0,24	AA212025020	BA212025020	WA212025020	25	20	25	58,5	31,6
32 x 20 x 32	pcs	90	10	0,07	0,38	AA212032020	BA212032020	WA212032020	32	20	32	61,4	31,5
32 x 25 x 32	pcs	80	10	0,07	0,38	AA212032025	BA212032025	WA212032025	32	25	32	69,1	36,0
40 x 20 x 40	pcs	60	10	0,09	0,46	AA212040020	BA212040020	WA212040020	40	20	40	64,0	38,1
40 x 25 x 40	pcs	50	10	0,13	0,64	AA212040025	BA212040025	WA212040025	40	25	40	73,5	39,6
40 x 32 x 40	pcs	50	10	0,13	0,64	AA212040032	BA212040032	WA212040032	40	32	40	79,3	42,4
50 x 25 x 50	pcs	40	4	0,18	0,96	AA212050025	BA212050025	WA212050025	50	25	50	76,3	49,7
50 x 32 x 50	pcs	30	2	0,19	0,96	AA212050032	BA212050032	WA212050032	50	32	50	82,6	45,9
50 x 40 x 50	pcs	14	2	0,21	0,96	AA212050040	BA212050040	WA212050040	50	40	50	90,3	47,7
63 x 32 x 63	pcs	10	2	0,35	1,92	AA212063032	BA212063032	WA212063032	63	32	63	94,7	52,3
63 x 40 x 63	pcs	10	2	0,34	1,92	AA212063040	BA212063040	WA212063040	63	40	63	98,7	53,9
63 x 50 x 63	pcs	10	2	0,39	1,92	AA212063050	BA212063050	WA212063050	63	50	63	107,3	56,8
90 x 63 x 90	pcs	5	1	0,77	4,80	AA212090063	BA212090063	WA212090063	90	63	90	132,9	73,4
90 x 75 x 90	pcs	5	1	0,85	4,80	AA212090075	BA212090075	WA212090075	90	75	90	142,6	76,4
125 x 75 x 125	pcs	1	1	2,35	7,64		BA212125075		125	75	125	248,0	104,0
125 x 90 x 125	pcs	1	1	2,30	7,72		BA212125090		125	90	125	248,0	106,0
125 x 110 x 125	pcs	1	1	2,38	7,88		BA212125110		125	110	125	248,0	110,0

FV PPR cross piece

System: **FV AQUA**
 Material: PPR
 Standard: ČSN EN ISO 15874, DIN 8077, DIN 8078
 Details: A simple, reliable fitting for branching the pipeline.

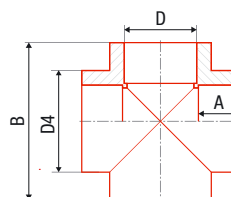

Code	Unit	100	200	Weight [kg]	Volume [dm³]	# ●	# ●	# ●*1	D [mm]	D4 [mm]	A [mm]	B [mm]
20	pcs	100	10	0,03	0,16	AA235020000	BA235020000	WA235020000	20	29	14,5	51,0
25	pcs	100	10	0,04	0,24	AA235025000	BA235025000	WA235025000	25	38	16,0	59,2
32	pcs	50	10	0,06	0,32	AA235032000	BA235032000	WA235032000	32	42	18,0	64,0

FV PPR reducing sleeve with plastic male thread

System: **FV AQUA**
 Material: PPR
 Standard: ČSN EN ISO 15874, DIN 8077, DIN 8078
 Details: A fitting for temporary threaded connection.

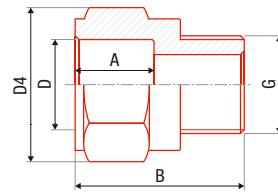

Icon	⊕	⊞	⊞	⊞	⊞	# ●	# ●	# ●*1	D [mm]	D4 [mm]	A [mm]	B [mm]	G
20 × 1/2"	pcs	300	20	0,01	0,03	AA213020012	BA213020012	WA213020012	20	30,8	14,5	34,5	1/2"
20 × 3/4"	pcs	100	20	0,02	0,04	AA213020034	BA213020034	WA213020034	20	36,4	14,5	44,5	3/4"
25 × 3/4"	pcs	100	20	0,02	0,05	AA213025034	BA213025034	WA213025034	25	40,5	16,0	45,0	3/4"
32 × 1"	pcs	100	10	0,03	0,10	AA213032001	BA213032001	WA213032001	32	50,0	18,1	55,0	1"
40 × 5/4"	pcs	60	10	0,07	0,20	AA213040054	BA213040054	WA213040054	40	68,2	20,5	56,8	5/4"
50 × 6/4"	pcs	40	10	0,12	0,35	AA213050064	BA213050064	WA213050064	50	84,8	23,5	65,0	6/4"
63 × 2"	pcs	20	2	0,22	0,50	AA213063002	BA213063002	WA213063002	63	107,0	27,4	75,0	2"

FV PPR tap elbow for welding internal

System: **FV AQUA**
 Material: PPR
 Standard: ČSN EN ISO 15874, DIN 8077, DIN 8078
 Details: A fitting for temporary threaded connection.

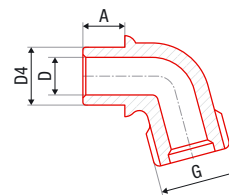

Icon	⊕	⊞	⊞	⊞	⊞	# ●	# ●	# ●*1	D [mm]	D4 [mm]	A [mm]	G
20 × 3/4"	pcs	150	10	0,02	0,08	AA207020034	BA207020034	WA207020034	20	23,0	14,5	3/4"
25 × 1"	pcs	100	10	0,03	0,10	AA207025001	BA207025001	WA207025001	25	28,5	16,0	1"

FV PPR threaded tap connector (fast)

System: **FV AQUA**
 Material: PPR
 Standard: ČSN EN ISO 15874, DIN 8077, DIN 8078
 Details: A connecting fitting for garden irrigation systems.

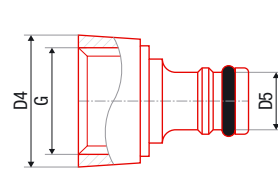

Icon	⊕	⊞	⊞	⊞	⊞	# ●	# ●	# ●*1	D4 [mm]	D5 [mm]	G
20 × 3/4"	pcs	250	50	0,01	0,05	AA256020034	BA256020034	WA256020034	32,7	15,6	3/4"
25 × 1"	pcs	250	50	0,01	0,08	AA256025001	BA256025001	WA256025001	38,6	15,6	1"

FV PPR blinding

System: **FV AQUA**
 Material: PPR
 Standard: ČSN EN ISO 15874, DIN 8077, DIN 8078
 Details: For permanent or temporary blinding of a branch.

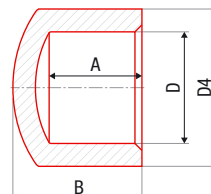

Icon	⊕	⊞	⊞	⊞	⊞	# ●	# ●	# ●*1	D [mm]	D4 [mm]	A [mm]	B [mm]
16	pcs	500	25	0,01	0,02	AA229016000	BA229016000	WA229016000	16	23,5	13,3	18,5
20	pcs	300	20	0,01	0,04	AA229020000	BA229020000	WA229020000	20	30,3	14,5	21,0
25	pcs	200	20	0,01	0,05	AA229025000	BA229025000	WA229025000	25	37,0	16,0	25,0
32	pcs	120	10	0,03	0,12	AA229032000	BA229032000	WA229032000	32	46,0	18,1	31,0
40	pcs	60	10	0,05	0,24	AA229040000	BA229040000	WA229040000	40	57,3	20,5	32,5
50	pcs	60	4	0,09	0,30	AA229050000	BA229050000	WA229050000	50	73,5	23,5	41,0
63	pcs	30	2	0,15	0,40	AA229063000	BA229063000	WA229063000	63	89,3	27,4	46,0
75	pcs	10	1	0,26	0,50	AA229075000	BA229075000	WA229075000	75	107,0	30,0	60,0
90	pcs	5	1	0,42	0,60	AA229090000	BA229090000	WA229090000	90	127,0	33,0	69,0
110	pcs	5	1	0,53	0,70	AA229110000	BA229110000	WA229110000	110	151,3	37,0	79,0
125	pcs	1	1	0,77	2,37		BA229125000		125	165,0	40,0	87,0

FV PPR threaded tap connector

System: **FV AQUA**
 Material: PPR
 Standard: ČSN EN ISO 15874, DIN 8077, DIN 8078
 Details: A connecting fitting for garden irrigation systems.
 * DN is the inside diameter of the hose tube in mm.

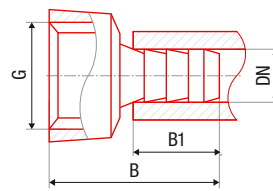

Icon	⊕	⊞	⊞	🔒	dm³	# ●	# ●	# ● *1	DN* [mm]	B [mm]	B1 [mm]	G
20 x 3/4"	pcs	450	50	0,01	0,05	AA280020034	BA280020034	WA280020034	20	41,1	24,0	3/4"
25 x 1"	pcs	300	25	0,01	0,08	AA280025001	BA280025001	WA280025001	25	46,0	27,4	1"

FV PPR blinding internal

System: **FV AQUA**
 Material: PPR
 Standard: ČSN EN ISO 15874, DIN 8077, DIN 8078
 Details: For permanent or temporary blinding of a branch.

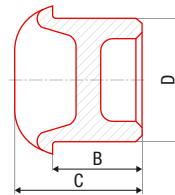

Icon	⊕	⊞	⊞	🔒	dm³	# ●	# ●	# ● *1	D [mm]	B [mm]	C [mm]
20	pcs	160	40	0,01	0,04	AA245020000	BA245020000	WA245020000	20	23,5	14,5
25	pcs	200	50	0,01	0,06	AA245025000	BA245025000	WA245025000	25	29,0	16,0

FV PPR pressure plug short

System: **FV AQUA**
 Material: PPR
 Standard: ČSN EN ISO 15874, DIN 8077, DIN 8078
 Details: For protection against mechanic impurities, non-pressure fitting.

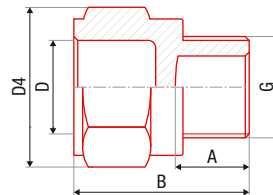

Icon	⊕	⊞	⊞	🔒	dm³	# ●	# ●	# ● *1	D [mm]	D4 [mm]	A [mm]	B [mm]	G
1/2"	pcs	400	50	0,01	0,04	AA253000000	BA253000000	WA253000000	20	30,8	14,5	34,5	1/2"

FV PPR all plastic weld in saddle

System: **FV AQUA**
 Material: PPR
 Standard: ČSN EN ISO 15874, DIN 8077, DIN 8078
 Details: For additional branches from existing pipeline.
 * Diameter hole is drilled to the desired diameter D1 of branch.

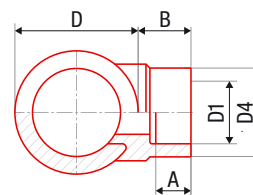

Icon	⊕	⊞	⊞	🔒	dm³	# ●	# ●	# ● *1	D [mm]	D1 [mm]	D4 [mm]	A [mm]	B [mm]
63 x 32	pcs	120	10	0,036	0,150	AA238063032	BA238063032	WA238063032	63	32	46,0	18	27
75 x 32	pcs	120	10	0,036	0,150	AA238075032	BA238075032	WA238075032	75	32	46,0	18	27
90 x 32	pcs	120	10	0,036	0,150	AA238090032	BA238090032	WA238090032	90	32	46,0	18	27
110 x 32	pcs	120	10	0,036	0,150	AA238110032	BA238110032	WA238110032	110	32	46,0	18	25,7
110 x 40	pcs	1	1	0,048	0,107	AA238110040	BA238110040	WA238110040	110	40	57,2	20,5	27
125 x 20	pcs	1	1	0,025	0,040		BA238125020		125	20	28,3	14,5	29
125 x 25	pcs	1	1	0,022	0,040		BA238125025		125	25	37,5	16	29
125 x 32	pcs	1	1	0,035	0,092		BA238125032		125	32	46,0	18	35
125 x 40	pcs	1	1	0,083	0,150		BA238125040		125	40	57,2	20,5	38
125 x 50	pcs	1	1	0,098	1,189		BA238125050		125	50	67,0	20,5	39
125 x 63	pcs	1	1	0,163	0,312		BA238125063		125	63	93,0	27	45

FV PP washer

System: **FV AQUA**

Material: PP

Standard: ČSN EN ISO 15874, DIN 8077, DIN 8078

Details: Delimitation of strengthening distribution within the installation in core housing.

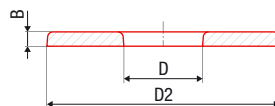

QTY	UNIT	PKT	PKT	PKT	PKT	#	#	#	D [mm]	D2 [mm]	B [mm]
66 x 22	pcs	300	1	0,01	0,01	AA251000000	BA251000000	WA251000000	21,3	64,8	4,3

FV PP pressure plug long

System: **FV AQUA**

Material: PP

Standard: -

Details: Temporary closure of threaded fittings for pressure test.



QTY	UNIT	PKT	PKT	PKT	PKT	#	#	#		
1/2"	pcs	120	10	0,02	0,14	AA252000001			blue	
1/2"	pcs	120	10	0,02	0,14		AA252000002		red	

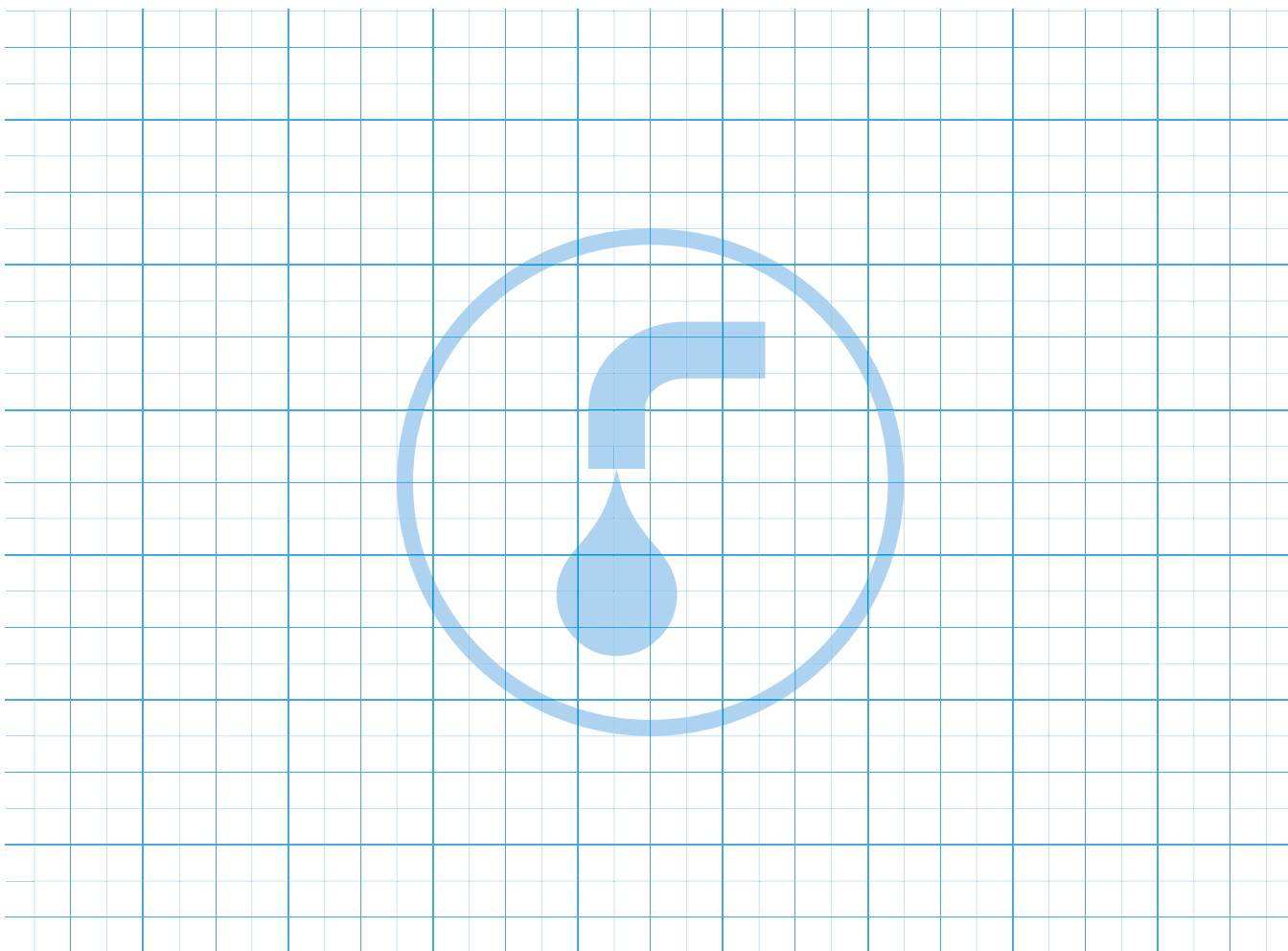

COMBINATION FITTINGS

FV PPR elbow 90° with metal male thread

System: **FV AQUA**
 Material: PPR - brass
 Standard: ČSN EN ISO 15874, DIN 8077, DIN 8078
 Details: Transition fitting from plastic part to metal part of pipeline.

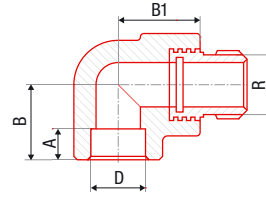

DN	pcs	10	15	20	dm³	# ●	# ●	# ● *1	D [mm]	B [mm]	B1 [mm]	A [mm]	R
16 x 1/2"	pcs	120	10	0,07	0,16	AA216016012	BM216016012	WA216016012	16	22	25	13,5	1/2"
20 x 1/2"	pcs	70	10	0,09	0,16	AA216020012	BM216020012	WA216020012	20	27	32	14,5	1/2"
20 x 3/4"	pcs	50	10	0,14	0,32	AA216020034	BM216020034	WA216020034	20	27	35	14,5	3/4"
25 x 1/2"	pcs	60	10	0,13	0,32	AA216025012	BM216025012	WA216025012	25	40	41	16,0	1/2"
25 x 3/4"	pcs	40	10	0,15	0,32	AA216025034	BM216025034	WA216025034	25	40	41	16,0	3/4"
32 x 1"	pcs	40	5	0,22	0,60	AA216032001	BM216032001	WA216032001	32	44	48	18,0	1"

FV PPR reducing sleeve with metal male thread

System: **FV AQUA**
 Material: PPR - brass
 Standard: ČSN EN ISO 15874, DIN 8077, DIN 8078
 Details: Transition fitting from plastic part to metal part of pipeline.

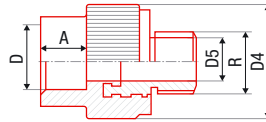

DN	pcs	10	15	20	dm³	# ●	# ●	# ● *1	D [mm]	D4 [mm]	D5 [mm]	A [mm]	R
16 x 1/2"	pcs	100	10	0,09	0,10	AA215016012	BM215016012	WA215016012	16	24,6	35,5	13,0	1/2"
20 x 1/2"	pcs	100	10	0,08	0,10	AA215020012	BM215020012	WA215020012	20	29,1	35,0	14,5	1/2"
20 x 3/4"	pcs	70	10	0,14	0,16	AA215020034	BM215020034	WA215020034	20	29,1	41,0	14,5	3/4"
25 x 1/2"	pcs	100	10	0,10	0,15	AA215025012	BM215025012	WA215025012	25	35,5	35,2	16,0	1/2"
25 x 3/4"	pcs	60	10	0,14	0,16	AA215025034	BM215025034	WA215025034	25	36,2	42,4	16,0	3/4"
32 x 1"	pcs	80	10	0,19	0,27	AA215032001	BM215032001	WA215032001	32	46,3	50,6	18,0	1"
40 x 5/4"	pcs	40	4	0,31	0,46	AA215040054	BM215040054	WA215040054	40	59,2	66,8	20,5	5/4"
50 x 6/4"	pcs	20	4	0,34	0,69	AA215050064	BM215050064	WA215050064	50	74,5	67,4	23,5	6/4"
63 x 2"	pcs	12	1	0,73	1,37	AA215063002	BM215063002	WA215063002	63	93,5	84,5	27,0	2"
75 x 2,5"	pcs	9	1	1,11	2,74	AA215075025	BM215075025	WA215075025	75	110,0	106,0	30,0	2,5"
90 x 3"	pcs	6	1	1,64	3,20	AA215090003	BM215090003	WA215090003	90	133,2	125,0	33,0	3"
125 x 5"	pcs	1	1	4,38	4,05		BM215125005		125	138,0	208,0	40,0	5"

FV PPR reducing sleeve with metal female thread

System: **FV AQUA**
 Material: PPR - brass
 Standard: ČSN EN ISO 15874, DIN 8077, DIN 8078
 Details: Transition fitting from plastic part to metal part of pipeline.

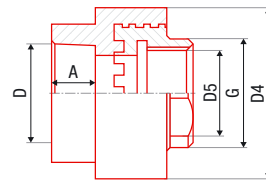

DN	pcs	10	15	20	dm³	# ●	# ●	# ● *1	D [mm]	D4 [mm]	D5 [mm]	A [mm]	G
16 x 1/2"	pcs	100	10	0,06	0,10	AA217016012	BM217016012	WA217016012	16	39,2	32,2	13,3	1/2"
20 x 1/2"	pcs	100	10	0,06	0,10	AA217020012	BM217020012	WA217020012	20	40,0	30,0	14,5	1/2"
20 x 3/4"	pcs	70	10	0,11	0,16	AA217020034	BM217020034	WA217020034	20	45,5	29,3	14,5	3/4"
25 x 1/2"	pcs	100	10	0,06	0,16	AA217025012	BM217025012	WA217025012	20	39,5	36,0	16,0	1/2"
25 x 3/4"	pcs	60	10	0,10	0,16	AA217025034	BM217025034	WA217025034	25	45,4	36,0	16,0	3/4"
32 x 1"	pcs	60	10	0,18	0,27	AA217032001	BM217032001	WA217032001	32	57,5	46,5	18,1	1"
40 x 5/4"	pcs	40	5	0,275	0,450	AA217040054	BM217040054	WA217040054	40	76,8	60,3	20,5	5/4"
50 x 6/4"	pcs	28	2	0,343	0,64	AA217050064	BM217050064	WA217050064	50	82,7	74,3	23,5	6/4"
63 x 2"	pcs	15	1	0,52	1,20	AA217063002	BM217063002	WA217063002	63	107,0	94,0	27,4	2"
125 x 5"	pcs	1	1				BM217125005		125	206,0	168,0	40,0	5"

FV PPR elbow 90° with metal female thread

System: **FV AQUA**
 Material: PPR - brass
 Standard: ČSN EN ISO 15874, DIN 8077, DIN 8078
 Details: Transition fitting from plastic part to metal part of pipeline.

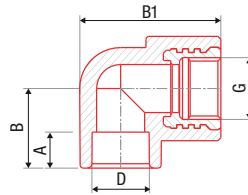

Symbol	Quantity	Weight	Volume	Volume	Volume	# ●	# ●	# ● *1	D [mm]	B [mm]	B1 [mm]	A [mm]	G
16 x 1/2"	pcs	150	10	0,07	0,16	AA218016012	BM218016012	WA218016012	16	22,0	25,0	13,5	1/2"
20 x 1/2"	pcs	80	10	0,06	0,16	AA218020012	BM218020012	WA218020012	20	27,0	32,0	14,5	1/2"
20 x 3/4"	pcs	50	10	0,13	0,32	AA218020034	BM218020034	WA218020034	20	27,0	35,0	14,5	3/4"
25 x 1/2"	pcs	60	10	0,10	0,32	AA218025012	BM218025012	WA218025012	25	40,0	41,0	16,0	1/2"
25 x 3/4"	pcs	50	10	0,12	0,32	AA218025034	BM218025034	WA218025034	25	40,0	41,0	16,0	3/4"
32 x 1"	pcs	40	5	0,20	0,60	AA218032001	BM218032001	WA218032001	32	44,0	48,0	18,0	1"

FV PPR weld in saddle with metal male thread

System: **FV AQUA**
 Material: PPR - brass
 Standard: ČSN EN ISO 15874, DIN 8077, DIN 8078
 Details: Transition fitting from plastic part to metal part of pipeline, for additional branches.

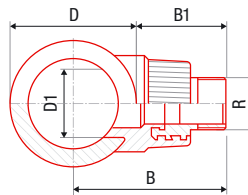

Symbol	Quantity	Weight	Volume	Volume	Volume	# ●	# ●	# ● *1	D [mm]	D1 [mm]	B [mm]	B1 [mm]	R
63 x 3/4"	pcs	120	10	0,112	0,170	AA248063032	BM248063032	WA248063032	63	32	76,3	44,8	3/4"
75 x 3/4"	pcs	120	10	0,117	0,170	AA248075032	BM248075032	WA248075032	75	32	82,3	44,8	3/4"
90 x 3/4"	pcs	120	10	0,112	0,170	AA248090032	BM248090032	WA248090032	90	32	89,8	44,8	3/4"
125 x 25 x 1/2"	pcs	1	1	0,090	0,048		BM248125025		63-125	25	73,5-104,5	42	1/2"
125 x 25 x 3/4"	pcs	1	1	0,132	0,056		BM248125026		63-125	25	80,5-111,5	49	3/4"
125 x 32 x 3/4"	pcs	1	1	0,116	0,100		BM248125032		63-125	32	80,5-111,5	49	3/4"
125 x 40 x 1"	pcs	1	1	0,234	0,168		BM248125040		75-125	40	91,5-116,5	54	1"
125 x 40 x 5/4"	pcs	1	1	0,314	0,168		BM248125041		75-125	40	91,5-116,5	54	1 1/4"
125 x 50 x 5/4"	pcs	1	1	0,342	0,227		BM248125050		90-125	50	104-121,5	59	1 1/4"
125 x 50 x 6/4"	pcs	1	1	0,350	0,227		BM248125051		90-125	50	104-121,5	59	1 1/2"
125 x 63 x 2"	pcs	1	1	0,632	0,227		BM248125063		110-125	63	95-102,5	40	2"

FV PPR weld in saddle with metal female thread

System: **FV AQUA**
 Material: PPR - brass
 Standard: ČSN EN ISO 15874, DIN 8077, DIN 8078
 Details: Transition fitting from plastic part to metal part of pipeline, for additional branches.

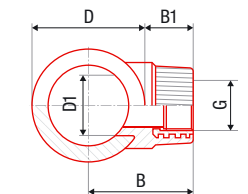

Symbol	Quantity	Weight	Volume	Volume	Volume	# ●	# ●	# ● *1	D [mm]	D1 [mm]	B [mm]	B1 [mm]	G
63 x 3/4"	pcs	120	10	0,091	0,17	AA247063032	BM247063032	WA247063032	63	32	58,5	27,00	3/4"
75 x 3/4"	pcs	120	10	0,091	0,17	AA247075032	BM247075032	WA247075032	75	32	64,5	27,00	3/4"
90 x 3/4"	pcs	120	10	0,090	0,17	AA247090032	BM247090032	WA247090032	90	32	72,0	27,00	3/4"
125 x 25 x 1/2"	pcs	1	1	0,058	0,03		BM247125025		63-125	25	60,5-91,5	29	1/2"
125 x 32 x 3/4"	pcs	1	1	0,102	0,07		BM247125032		63-125	32	66,5-97,5	35	3/4"
125 x 40 x 1"	pcs	1	1	0,194	0,12		BM247125040		75-125	40	75,5-100,5	38	1"
125 x 40 x 5/4"	pcs	1	1	0,194	0,12		BM247125041		75-125	40	75,5-100,5	38	1 1/4"
125 x 50 x 5/4"	pcs	1	1	0,240	0,15		BM247125050		90-125	50	84-101,5	39	1 1/4"
125 x 50 x 6/4"	pcs	1	1	0,244	0,15		BM247125051		90-125	50	84-101,5	39	1 1/2"
125 x 63 x 2"	pcs	1	1	0,490	0,26		BM247125063		110-125	63	100-107,5	45	2"

FV PPR reducing sleeve with metal female thread with cross

System: **FV AQUA**
 Material: PPR - brass
 Standard: ČSN EN ISO 15874, DIN 8077, DIN 8078
 Details: Transition fitting from plastic part to metal part of pipeline.

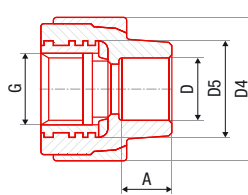

Symbol	Quantity	Weight	Volume	Volume	Volume	# ●	# ●	# ● *1	D [mm]	D4 [mm]	D5 [mm]	A [mm]	G
20 x 1/2"	pcs	100	10	0,06	0,11	AA217022012	BM217022012	WA217022012	20	38	28,1	14,5	1/2"

FV PPR tee with metal female thread

System: **FV AQUA**
 Material: PPR - brass
 Standard: ČSN EN ISO 15874, DIN 8077, DIN 8078
 Details: Transition fitting from plastic part to metal part of pipeline.

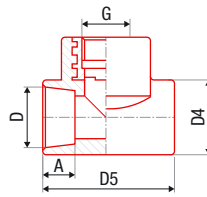

Objekt	Symbol	Skupina	Podskupina	Objem	hm ³	# ●	# ●	# ● *1	D [mm]	D4 [mm]	D5 [mm]	A [mm]	G
20 x 1/2"	pcs	60	10	0,07	0,19	AA222020012	BM222020012	WA222020012	20	29,0	37,0	14,5	1/2"
25 x 1/2"	pcs	40	10	0,08	0,24	AA222025012	BM222025012	WA222025012	25	36,0	37,0	16,0	1/2"
25 x 3/4"	pcs	30	10	0,13	0,32	AA222025034	BM222025034	WA222025034	25	38,4	46,5	16,0	3/4"
32 x 1"	pcs	40	5	0,22	0,60	AA222032001	BM222032001	WA222032001	32	48,4	58,0	18,1	1"

FV PPR tee with metal male thread

System: **FV AQUA**
 Material: PPR - brass
 Standard: ČSN EN ISO 15874, DIN 8077, DIN 8078
 Details: Transition fitting from plastic part to metal part of pipeline.

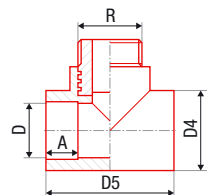

Objekt	Symbol	Skupina	Podskupina	Objem	hm ³	# ●	# ●	# ● *1	D [mm]	D4 [mm]	D5 [mm]	A [mm]	R
20 x 1/2"	pcs	100	10	0,09	0,19	AA254020012	BM254020012	WA254020012	20	29,2	36,8	14,5	1/2"
25 x 1/2"	pcs	40	10	0,10	0,24	AA254025012	BM254025012	WA254025012	25	37,0	41,0	16,0	1/2"
25 x 3/4"	pcs	30	10	0,17	0,32	AA254025034	BM254025034	WA254025034	32	37,0	41,0	16,0	3/4"

FV PPR metal reducer with cap nut

System: **FV AQUA**
 Material: PPR - brass
 Standard: ČSN EN ISO 15874, DIN 8077, DIN 8078
 Details: Transition fitting from plastic part to metal part of pipeline.

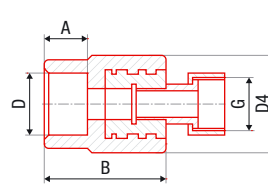

Objekt	Symbol	Skupina	Podskupina	Objem	hm ³	# ●	# ●	# ● *1	D [mm]	D4 [mm]	A [mm]	B [mm]	G
16 x 1/2"	pcs	120	10	0,05	0,05	AA223016012	BM223016012	WA223016012	16	37	13,3	33,6	1/2"
16 x 3/4"	pcs	100	10	0,08	0,06	AA223016034	BM223016034	WA223016034	16	37	13,3	37,0	3/4"
20 x 1/2"	pcs	120	10	0,05	0,05	AA223020012	BM223020012	WA223020012	20	37	14,5	33,6	1/2"
20 x 3/4"	pcs	100	10	0,08	0,06	AA223020034	BM223020034	WA223020034	20	37	14,5	37,0	3/4"
20 x 1"	pcs	50	10	0,23	0,06	AA223020001	BM223020001	WA223020001	20	43	14,5	43,0	1"
25 x 3/4"	pcs	100	10	0,26	0,06	AA223025034	BM223025034	WA223025034	25	37	16,0	39,0	3/4"
25 x 1"	pcs	40	10	0,26	0,07	AA223025001	BM223025001	WA223025001	25	43	16,0	44,0	1"
32 x 5/4"	pcs	25	5	0,38	0,12	AA223032054	BM223032054	WA223032054	32	52	18,1	47,5	5/4"

FV PPR union plastic / brass unwelded

System: **FV AQUA**
 Material: PPR - brass
 Standard: ČSN EN ISO 15874, DIN 8077, DIN 8078
 Details: Transition fitting from plastic part to metal part of pipeline. | * with a hole for seal

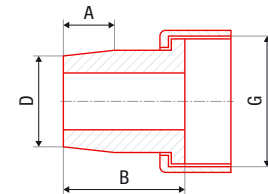

Objekt	Symbol	Skupina	Podskupina	Objem	hm ³	# ●	# ●	# ● *1	D [mm]	A [mm]	B [mm]	G
20 x 3/4"	pcs	150	50	0,04	0,05	AA225020034	BM225020034	WA225020034	20	14,5	35,5	3/4"
25 x 1"	pcs	80	20	0,07	0,10	AA225025001	BM225025001	WA225025001	25	16,0	45,2	1"
32 x 5/4"	pcs	45	15	0,10	0,18	AA225032054	BM225032054	WA225032054	32	18,0	45,3	5/4"
40 x 6/4"	pcs	40	1	0,16	0,22	AA225040064	BM225040064	WA225040064	40	20,5	51,5	6/4"
50 x 2"	pcs	20	1	0,30	0,41	AA225050002	BM225050002	WA225050002	50	23,5	60,5	2"
* 20 x 3/4"	pcs	150	50	0,04	0,05	AA225020134	BM225020134	WA225020134	20	14,8	35,5	3/4"

FV PPR plastic reducing sleeve with cap nut

System: **FV AQUA**
 Material: PPR - brass
 Standard: ČSN EN ISO 15874, DIN 8077, DIN 8078
 Details: Transition fitting from plastic part to metal part of pipeline | * with a hole for seal

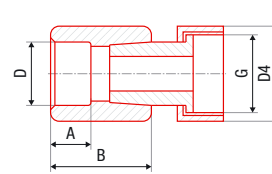

Q _{lin}	⊕	⊞	⊞	⊞	⊞	# ●	# ●	# ● ⁺¹	D [mm]	D4 [mm]	A [mm]	B [mm]	G
16 × 3/4"	pcs	220	20	0,05	0,16	AA226016034	BM226016034	WA226016034	16	29,2	13,0	33,1	3/4"
20 × 1/2"	pcs	300	25	0,04	0,16	AA226020012	BM226020012	WA226020012	20	29,2	14,5	34,0	1/2"
20 × 3/4"	pcs	200	20	0,05	0,16	AA226020034	BM226020034	WA226020034	20	28,6	14,5	32,4	3/4"
25 × 3/4"	pcs	150	10	0,05	0,19	AA226025034	BM226025034	WA226025034	25	36,8	16,0	34,4	3/4"
25 × 1"	pcs	120	10	0,09	0,19	AA226025001	BM226025001	WA226025001	25	36,7	16,0	35,0	1"
32 × 1"	pcs	100	10	0,10	0,48	AA226032001	BM226032001	WA226032001	32	47,0	18,0	38,0	1"
* 20 × 3/4"	pcs	200	20	0,05	0,16	AA226020134	BM226020134	WA226020134	20	28,6	14,5	32,0	3/4"
* 25 × 3/4"	pcs	150	10	0,05	0,19	AA226025134	BM226025134	WA226025134	32	36,8	16,0	34,0	3/4"

FV PPR coupling with nut

System: **FV AQUA**
 Material: PPR - brass
 Standard: ČSN EN ISO 15874, DIN 8077, DIN 8078
 Details: Mountable and demountable joint.

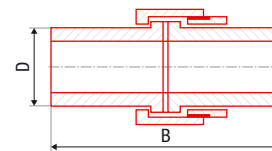

Q _{lin}	⊕	⊞	⊞	⊞	⊞	# ●	# ●	# ● ⁺¹	D [mm]	B [mm]
20	pcs	200	10	0,08	0,15	AA224020000	BM224020000	WA224020000	20	73,0
25	pcs	120	5	0,12	0,20	AA224025000	BM224025000	WA224025000	25	93,5
32	pcs	70	5	0,19	0,25	AA224032000	BM224032000	WA224032000	32	93,5
40	pcs	50	5	0,27	0,35	AA224040000	BM224040000	WA224040000	40	105,0
50	pcs	25	5	0,49	0,65	AA224050000	BM224050000	WA224050000	50	123,0

FV PPR elbow 90° plastic reducing sleeve with cap nut

System: **FV AQUA**
 Material: PPR - brass
 Standard: ČSN EN ISO 15874, DIN 8077, DIN 8078
 Details: Transition fitting from plastic part to metal part of pipeline | * with a hole for seal

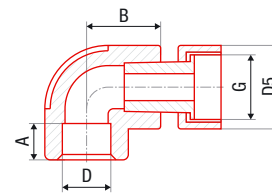

Q _{lin}	⊕	⊞	⊞	⊞	⊞	# ●	# ●	# ● ⁺¹	D [mm]	D4 [mm]	A [mm]	B [mm]	G
20 × 1/2"	pcs	250	25	0,04	0,02	AA227020012	BM227020012	WA227020012	20	29,0	14,5	29,3	1/2"
20 × 3/4"	pcs	180	20	0,06	0,03	AA227020034	BM227020034	WA227020034	25	30,0	14,5	25,5	3/4"
25 × 3/4"	pcs	120	10	0,06	0,10	AA227025034	BM227025034	WA227025034	32	36,6	16,0	32,0	3/4"
* 20 × 3/4"	pcs	180	20	0,06	0,02	AA227020134	BM227020134	WA227020134	20	30,0	14,5	25,5	3/4"

FV PPR tee plastic reducing sleeve with cap nut

System: **FV AQUA**
 Material: PPR - brass
 Standard: ČSN EN ISO 15874, DIN 8077, DIN 8078
 Details: Transition fitting from plastic part to metal part of pipeline | * with a hole for seal

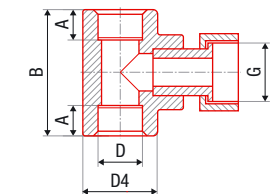

Q _{lin}	⊕	⊞	⊞	⊞	⊞	# ●	# ●	# ● ⁺¹	D [mm]	D4 [mm]	A [mm]	B [mm]	G
20 × 3/4" × 20	pcs	130	10	0,07	0,24	AA228020034	BM228020034	WA228020034	20	29,0	14,5	51,0	3/4"
25 × 3/4" × 25	pcs	80	10	0,08	0,32	AA228025034	BM228025034	WA228025034	25	36,6	16,0	58,0	3/4"
32 × 3/4" × 32	pcs	60	10	0,11	0,38	AA228032034	BM228032034	WA228032034	32	46,0	18,1	61,4	3/4"
32 × 1" × 32	pcs	50	10	0,13	0,38	AA228032044	BM228032044	WA228032044	32	45,6	18,1	69,0	1"
* 20 × 3/4" × 20	pcs	120	20	0,07	0,24	AA228020134	BM228020134	WA228020134	20	29,0	14,5	51,0	3/4"
* 25 × 3/4" × 25	pcs	80	10	0,08	0,32	AA228025134	BM228025134	WA228025134	25	36,6	16,0	58,0	3/4"

FV PPR flange adaptor

System: **FV AQUA**
 Material: PPR
 Standard: ČSN EN ISO 15874, DIN 8077, DIN 8078
 Details: Plastic fitting for flange dismountable joints.

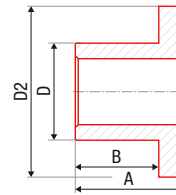

Icon	⊕	⊞	⊞	⊞	dm ²	# ●	# ●	# ● *1	D [mm]	DN [mm]	D2 [mm]	A [mm]	B [mm]
40/32	pcs	40	4	0,07	0,35	AA230040032	BA230040032	WA230040032	40	32	78	50	38,0
50/40	pcs	40	2	0,10	0,55	AA230050040	BA230050040	WA230050040	50	40	98	55	43,0
63/50	pcs	20	2	0,15	0,67	AA230063050	BA230063050	WA230063050	60	50	112	60	46,5
75/65	pcs	15	1	0,26	1,20	AA230075065	BA230075065	WA230075065	75	65	122	66	50,0
90/80	pcs	10	1	0,37	1,35	AA230090080	BA230090080	WA230090080	90	80	135	82	63,0
110/100	pcs	5	1	0,62	2,45	AA230110100	BA230110100	WA230110100	110	100	163	100	82,0
125/100	pcs	1	1	0,36	2,34		BA230125100		125	100	162	53	40,0
125/125	pcs	1	1	1,34	5,38		BA230125125		125	125	188	185	145

FV PPR FE flange

System: **FV AQUA**
 Material: cast-iron
 Standard: ČSN EN ISO 15874, DIN 8077, DIN 8078
 Details: Metal fitting for flange dismountable joints.

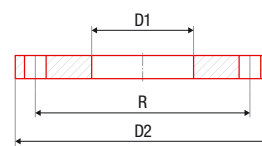

Icon	⊕	⊞	⊞	⊞	dm ²	# ●	# ●	# ● *1	D1 [mm]	D2 [mm]	R [mm]	d	no. of holes
40/32	pcs	1	1	1,42	0,35	AA231040032			43	140	100	M 16	4
50/40	pcs	1	1	1,82	0,38	AA231050040			53	150	110	M 16	4
63/50	pcs	1	1	2,23	0,45	AA231063050			66	165	125	M 16	4
75/65	pcs	1	1	2,48	0,55	AA231075065			78	185	145	M 16	4
90/80	pcs	1	1	3,25	0,80	AA231090080			95	200	160	M 16	8
110/100	pcs	1	1	3,60	0,97	AA231110100			114	220	180	M 16	8
125/100	pcs	1	1	1,078	0,68	AA231125100			149	220	180	M 16	8
125/125	pcs	1	1	1,844	1,18	AA231125125			158	250	210	M 16	8

FV PPR transition union male

System: **FV AQUA**
 Material: PPR - brass
 Standard: ČSN EN ISO 15874, DIN 8077, DIN 8078
 Details: Transition demountable fitting from plastic part to metal part of pipeline.

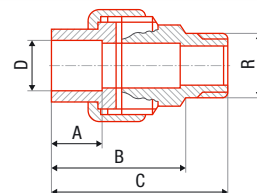

Icon	⊕	⊞	⊞	⊞	dm ²	# ●	# ●	# ● *1	D [mm]	A [mm]	B [mm]	C [mm]	R
20 × 1/2"	pcs	125	1	0,11	0,09	AA237020012	BM237020012	WA237020012	20	14,5	41	53	1/2"
25 × 3/4"	pcs	65	1	0,19	0,17	AA237025034	BM237025034	WA237025034	25	16,0	44	59	3/4"
32 × 1"	pcs	50	1	0,25	0,22	AA237032001	BM237032001	WA237032001	32	18,1	46	63	1"
40 × 5/4"	pcs	25	1	0,36	0,44	AA237040054	BM237040054	WA237040054	40	20,5	51	68	5/4"
50 × 6/4"	pcs	20	1	0,59	0,55	AA237050064	BM237050064	WA237050064	50	23,5	52	70	6/4"
63 × 2"	pcs	8	1	1,03	1,37	AA237063002	BM237063002	WA237063002	63	27,4	64	90	2"

FV PPR transition union female

System: **FV AQUA**
 Material: PPR - brass
 Standard: ČSN EN ISO 15874, DIN 8077, DIN 8078
 Details: Transition demountable fitting from plastic part to metal part of pipeline.

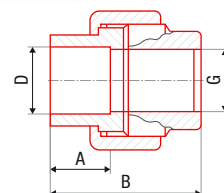

Icon	⊕	⊞	⊞	⊞	dm ²	# ●	# ●	# ● *1	D [mm]	A [mm]	B [mm]	G
20 × 1/2"	pcs	150	1	0,10	0,07	AA236020012	BM236020012	WA236020012	20	14,5	41	1/2"
25 × 3/4"	pcs	75	1	0,16	0,15	AA236025034	BM236025034	WA236025034	25	16,0	44	3/4"
32 × 1"	pcs	50	1	0,19	0,22	AA236032001	BM236032001	WA236032001	32	18,0	46	1"
32 × 5/4"	pcs	50	1	0,29	0,36	AA236032054	BM236032054	WA236032054	32	18,0	51	5/4"
40 × 5/4"	pcs	30	1	0,32	0,36	AA236040054	BM236040054	WA236040054	40	20,5	51	5/4"
50 × 6/4"	pcs	25	1	0,48	0,55	AA236050064	BM236050064	WA236050064	50	23,5	52	6/4"
63 × 2"	pcs	8	1	0,82	1,37	AA236063002	BM236063002	WA236063002	63	27,4	64	2"

FV PPR elbow 90° for wall mounting

System: **FV AQUA**

Material: PPR - brass

Standard: ČSN EN ISO 15874, DIN 8077, DIN 8078

Details: Fixing fitting with tap connector for mixers.

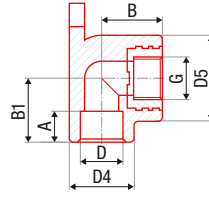

Icon	⊕	⊞	⊞	⊞	⊞	# ●	# ●	# ●*1	D [mm]	D5 [mm]	D4 [mm]	B [mm]	G
16 x 1/2"	pcs	50	10	0,07	0,22	AA219016012	BM219016012	WA219016012	16	38,6	28,2	35,0	1/2"
20 x 1/2"	pcs	100	10	0,07	0,36	AA219020012	BM219020012	WA219020012	20	39,6	30,2	34,3	1/2"
25 x 1/2"	pcs	30	10	0,12	0,55	AA219025012	BM219025012	WA219025012	25	46,4	37,2	40,0	1/2"
25 x 3/4"	pcs	30	10	0,13	1,37	AA219025034	BM219025034	WA219025034	25	46,4	37,2	40,0	3/4"

FV PPR elbow 90° for wall mounting intenal / external

System: **FV AQUA**

Material: PPR - brass

Standard: ČSN EN ISO 15874, DIN 8077, DIN 8078

Details: Fixing fitting with tap connector for mixers.

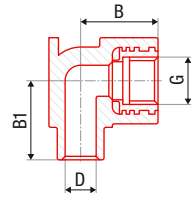

Icon	⊕	⊞	⊞	⊞	⊞	# ●	# ●	# ●*1	D [mm]	B [mm]	B1 [mm]	C [mm]	G
20 x 1/2"	pcs	100	10	0,06	0,21	AA239020012	BM239020012	WA239020012	20	35	35	11	1/2"

FV PPR wall mounting elbow with metal female thread LEFT and RIGHT

System: **FV AQUA**

Material: PPR - brass

Standard: ČSN EN ISO 15874, DIN 8077, DIN 8078

Details: Fixing fitting with tap connector for mixers.

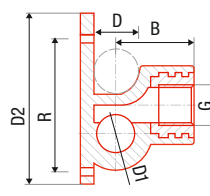

Icon	⊕	⊞	⊞	⊞	⊞	# ●	# ●	# ●*1	D [mm]	B [mm]	R [mm]	D2 [mm]	G
left 20 x 1/2"	pcs	100	10	0,078	0,216	AA219020013			20	34	62,1	74	1/2"
right 20 x 1/2"	pcs	100	10	0,078	0,216	AA219020014			20	34	62,1	74	1/2"

FV PPR elbow with metal female thread UNI

System: **FV AQUA**

Material: PPR - brass

Standard: ČSN EN ISO 15874, DIN 8077, DIN 8078

Details: Fixing fitting with tap connector for mixers.

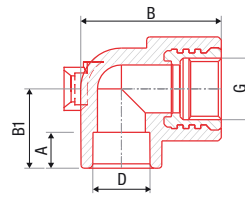

Icon	⊕	⊞	⊞	⊞	⊞	# ●	# ●	# ●*1	D [mm]	B [mm]	B1 [mm]	A [mm]	G
20 x 1/2"	pcs	120	10	0,06	0,15	AA258020012	BM258020012	WA258020012	20	54	27	14,5	1/2"

FV PPR holder MONO for UNI elbow

System: **FV AQUA**

Material: PPR

Standard: ČSN EN ISO 15874, DIN 8077, DIN 8078

Details: Fixing fitting with tap connector for mixers.

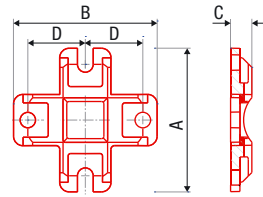

Icon	⊕	⊞	⊞	⊞	⊞	# ●	# ●	# ●*1	D [mm]	B [mm]	A [mm]	C [mm]
20 x 1/2"	pcs	200	10	0,008	0,036	AA258800000			24	60	60	8,9

FV PPR holder DUO for UNI elbow

System: **FV AQUA**
 Material: PPR
 Standard: ČSN EN ISO 15874, DIN 8077, DIN 8078
 Details: Fixing fitting with tap connector for mixers.

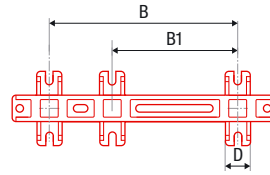

Icon	Symbol	Icon	Icon	Icon	Icon	Icon	# ●	# ●	# ● *1	D [mm]	B [mm]	B1 [mm]
20 x 1/2"	pcs	120	10	0,029	0,180	AA258900000				20	150	100

FV PPR wall elbows with holder

System: **FV AQUA**
 Material: PPR - brass
 Standard: ČSN EN ISO 15874, DIN 8077, DIN 8078
 Details: Tap water connector with adjustable distance of 100 or 150 mm.

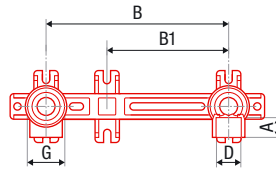

Icon	Symbol	Icon	Icon	Icon	Icon	Icon	# ●	# ●	# ● *1	D [mm]	A [mm]	B [mm]	B1 [mm]	G
20 x 1/2"	pcs	30	5	0,163	0,60	AA255020012	BM255020012	WA255020012		20	15	150	100	1/2"

FV PPR elbow for gypsum wall mounting

System: **FV AQUA**
 Material: PPR - brass
 Standard: ČSN EN ISO 15874, DIN 8077, DIN 8078
 Details: Fixing fitting with tap connector for mixers, for gypsum walls.

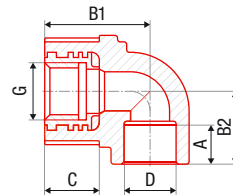

Icon	Symbol	Icon	Icon	Icon	Icon	Icon	# ●	# ●	# ● *1	D [mm]	A [mm]	B1, B2 [mm]	C [mm]	G
20 x 1/2"	pcs	50	1	0,13	1,02	AA240020012	BM240020012	WA240020012		20	15	42, 27	25	1/2"

FV PPR tee with tap connector

System: **FV AQUA**
 Material: PPR - brass
 Standard: ČSN EN ISO 15874, DIN 8077, DIN 8078
 Details: Fixing fitting with tap connector for mixers.

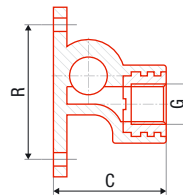

Icon	Symbol	Icon	Icon	Icon	Icon	Icon	# ●	# ●	# ● *1	D [mm]	A [mm]	C [mm]	R [mm]	G
20 x 1/2"	pcs	60	10	0,08	0,21	AA220020012	BM220020012	WA220020012		20	14,5	50	61,5	1/2"
25 x 1/2"	pcs	50	10	0,09	0,36	AA220025012	BM220025012	WA220025012		25	16,0	56	75,0	1/2"

FV PPR wall mounting group with tap connectors

System: **FV AQUA**
 Material: PPR - brass
 Standard: -
 Details: Tap water connectors with adjustable distance of 100 or 150 mm. Set pitch 105/130/145 and 110/125/140 mm, need to be balance with an eccentric tray.

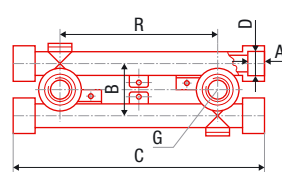

Icon	Symbol	Icon	Icon	Icon	Icon	Icon	# ●	# ●	# ● *1	D [mm]	A [mm]	B [mm]	C [mm]	G
2 x 20 x 1/2"	pcs	15	1	0,20	1,37	AA221020012	BM221020012	WA221020012		20	14,5	46	222	1/2"
2 x 25 x 1/2"	pcs	10	1	0,31	1,32	AA221025012	BM221025012	WA221025012		25	16,0	51	230	1/2"

FV PPR assembling plate for elbow 90° for wall mounting

System: **FV AQUA**

Material: PPR

Standard: -

Details: A practical accessory for an easy installation into dry building systems. Thickness 4 mm.

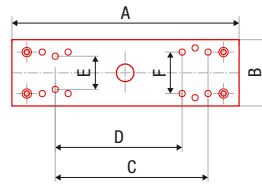

Icon	⊕	⊞	⊞	⊞	📦	dm³	# ●	# ●	# ●*1	A [mm]	B [mm]	C [mm]	D [mm]	E, F [mm]
	pcs	60	1		0,08	0,15	AA251000001			220	64	135	110	40, 45

FV PPR electro-fusion socket

System: **FV AQUA**

Material: PPR - brass

Standard: -

Details: A fitting for pipe connection under electro-fusion welding condition.

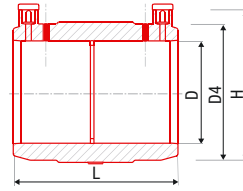

Icon	⊕	⊞	⊞	📦	dm³	# ●	# ●	# ●*1	D [mm]	D4 [mm]	L [mm]	H [mm]
20	pcs	1	1			AA234020000			20			
25	pcs	1	1	0,075	0,438	AA234025000			25	40	40	53
32	pcs	1	1	0,097	0,500	AA234032000			32	47	47	60
40	pcs	1	1	0,127	0,583	AA234040000			40	56	56	69
50	pcs	1	1	0,210	0,875	AA234050000			50	70	70	83
63	pcs	1	1	0,320	1,400	AA234063000			63	84	84	97
75	pcs	1	1	0,487	1,750	AA234075000			75	100	100	113
90	pcs	1	1	0,565		AA234090000			90	120	120	133
110	pcs	1	1			AA234110000			110	146	146	159
125	pcs	1	1				BA234125000		125	156	151	168

FV PPR joining elbow 45° to the radiator

System: **FV AQUA**

Material: PPR - brass

Standard: -

Details: For radiator connection.

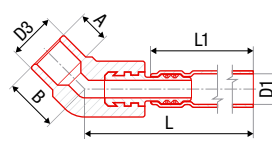

Icon	⊕	⊞	⊞	📦	dm³	# ●	# ●	# ●*1	A [mm]	B [mm]	D1, D3 [mm]	L [mm]	L1 [mm]
20	pcs	20	1	0,126		AA244020270		WA244020270	14,5	24	15, 20	300	270
20	pcs	10	1	0,273		AA244020720		WA244020720	14,5	24	15, 20	750	720

FV PPR joining elbow 90° to the radiator

System: **FV AQUA**

Material: PPR - brass

Standard: -

Details: For radiator connection.

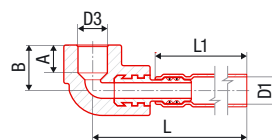

Icon	⊕	⊞	⊞	📦	dm³	# ●	# ●	# ●*1	A [mm]	B [mm]	D1, D3 [mm]	L [mm]	L1 [mm]
20	pcs	20	1	0,123		AA243020270		WA243020270	13	22,5	15, 20	298	270
20	pcs	10	1	0,270		AA243020720		WA243020720	13	22,5	15, 20	748	720

FV PPR sleeve euroconus with metal thread

System: **FV AQUA**

Material: PPR - brass

Standard: -

Details: Transition fitting for radiator connection.

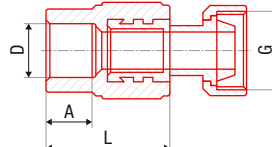

Icon	⊕	⊞	⊞	📦	dm³	# ●	# ●	# ●*1	D [mm]	A [mm]	L [mm]	G
20 × 3/4"	pcs	100	10	0,091	0,154	AA257020034		WA257020034	20	14,5	40	3/4"

CLOSING FITTINGS

FV PPR ball valve plastic with a butterfly

FV PPR ball valve plastic with a lever

System: **FV AQUA**
 Material: PPR - brass
 Standard: ČSN EN ISO 15874, DIN 8077, DIN 8078
 Details: A ball cock with a chromed ball and teflon seals.

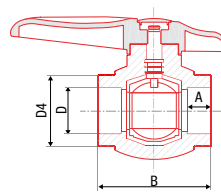

DN	Symbol	Symbol	Symbol	Symbol	Symbol	Symbol	# ●	# ●	# ● *1		D [mm]	D4 [mm]	A [mm]	B [mm]
16	pcs	40	10	0,12	0,17	AA271016000	BM271016000	WA271016000	with a butterfly	16	22,8	13,0	58,6	
20	pcs	40	10	0,12	0,34	AA271020000	BM271020000	WA271020000	with a butterfly	20	31,2	14,5	61,1	
20	pcs	40	10	0,12	0,34	AA271020100	BM271020100	WA271020100	with a lever	20	31,2	14,5	61,1	
25	pcs	40	4	0,21	0,69	AA271025000	BM271025000	WA271025000	with a lever	25	37,4	16,0	74,5	
32	pcs	20	2	0,36	0,69	AA271032000	BM271032000	WA271032000	with a lever	32	48,5	18,0	85,0	
40	pcs	15	1	0,36	1,60	AA271040000	BM271040000	WA271040000	with a lever	40	60,4	20,5	98,0	
50	pcs	9	1	0,65	1,60	AA271050000	BM271050000	WA271050000	with a lever	50	75,0	23,5	116,3	
63	pcs	6	1	1,12	4,80	AA271063000	BM271063000	WA271063000	with a lever	63	92,5	27,5	131,0	
75	pcs	4	1	1,83	4,80	AA271075000	BM271075000	WA271075000	with a lever	75	108,0	30,0	165,0	

FV PPR radiator ball valve straight

System: **FV AQUA**
 Material: PPR - brass
 Standard: ČSN EN ISO 15874, DIN 8077, DIN 8078
 Details: A ball cock with a chromed ball and teflon seals.

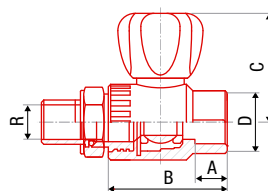

DN	Symbol	Symbol	Symbol	Symbol	Symbol	Symbol	# ●	# ●	# ● *1	D [mm]	D4 [mm]	A [mm]	B [mm]	C [mm]
20 x 1/2"	pcs	60	1	0,154	0,12	AA289020012		WA289020012		20	29	16,1	55,1	52
25 x 3/4"	pcs	40	1	0,198	0,16	AA289025034		WA289025034		25	36,5	17,1	60,2	56

FV PPR radiator ball valve elbow

System: **FV AQUA**
 Material: PPR - brass
 Standard: ČSN EN ISO 15874, DIN 8077, DIN 8078
 Details: A ball cock with a chromed ball and teflon seals.

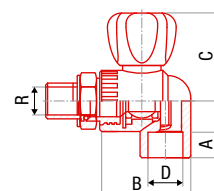

DN	Symbol	Symbol	Symbol	Symbol	Symbol	Symbol	# ●	# ●	# ● *1	D [mm]	D4 [mm]	A [mm]	B [mm]	C [mm]
20 x 1/2"	pcs	50	1	0,160	0,13	AA290020012		WA290020012		20	29	15,1	51	52
25 x 3/4"	pcs	40	1	0,198	0,18	AA290025034		WA290025034		25	36,5	17,1	60,5	56

FV PPR ball valve plastic with PV valve

System: **FV AQUA**
 Material: PPR - brass
 Standard: ČSN EN ISO 15874, DIN 8077, DIN 8078
 Details: A ball cock with a chromed ball and teflon seals. see note* page 39

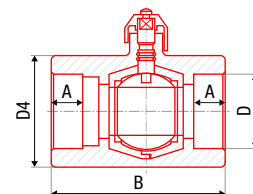

DN	Symbol	Symbol	Symbol	Symbol	Symbol	Symbol	# ●	# ●	# ● *1	D [mm]	D4 [mm]	A [mm]	B [mm]
20	pcs	60	10	0,14	0,37	AA272020000	BA272020000	WA272020000		20	31,4	14,5	74,5
25	pcs	60	10	0,14	0,40	AA272025000	BA272025000	WA272025000		25	38,2	16,0	78,5
32	pcs	30	2	0,24	0,80	AA272032000	BA272032000	WA272032000		32	49,0	18,0	91,0
40	pcs	20	2	0,38	1,60	AA272040000	BA272040000	WA272040000		40	60,0	20,5	105,0
50	pcs	14	1	0,66	1,60	AA272050000	BA272050000	WA272050000		50	76,0	23,5	121,5
63	pcs	6	1	1,14	4,80	AA272063000	BA272063000	WA272063000		63	94,0	27,5	144,0
75	pcs	5	1	1,85	4,80	AA272075000	BA272075000	WA272075000		75	108,0	30,0	165,0

Note: *The hexagonal valve at the valve body is a structural element that serves to lock and prevent reversing when the valve is released. Never turn the hexagon. To open the discharge valve, a manually operated perimeter cut-out screw is provided. Anticlockwise, the valve opens and closes clockwise.

FV PPR ball valve with threaded elbow for hose connection

System: **FV AQUA**
 Material: PPR - brass
 Standard: ČSN EN ISO 15874, DIN 8077, DIN 8078
 Details: A plastic tap for garden purposes.

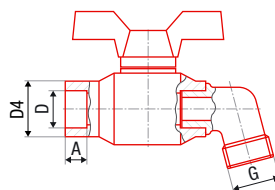

Icon	⊕	⊞	⊞	⊞	⊞	# ●	# ●	# ●*1	D [mm]	D4 [mm]	A [mm]	B [mm]	G
	pcs	40	1	0,14	0,39	AA273020000	BA273020000	WA273020000	20	31,2	14,5	96	3/4"
	pcs	30	1	0,15	0,77	AA273025000	BA273025000	WA273025000	25	37,4	16,0	117	1"

FV PPR valve with threaded elbow for hose connection

System: **FV AQUA**
 Material: PPR - brass
 Standard: ČSN EN ISO 15874, DIN 8077, DIN 8078
 Details: A plastic tap for garden purposes.

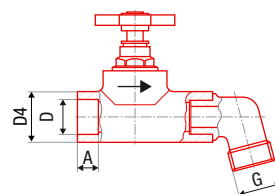

Icon	⊕	⊞	⊞	⊞	⊞	# ●	# ●	# ●*1	D [mm]	D4 [mm]	A [mm]	B [mm]	G
	pcs	50	10	0,17	0,65	AA276020000	BA276020000	WA276020000	20	30,0	14,5	112,5	3/4"
	pcs	40	10	0,24	0,68	AA276025000	BA276025000	WA276025000	25	37,3	16,0	125,0	1"

FV PPR straight-way valve

System: **FV AQUA**
 Material: PPR - brass
 Standard: ČSN EN ISO 15874, DIN 8077, DIN 8078
 Details: A valve allowing closing or regulation of the flow of water.

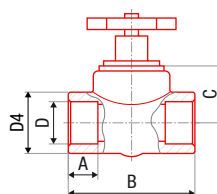

Icon	⊕	⊞	⊞	⊞	⊞	# ●	# ●	# ●*1	D [mm]	D4 [mm]	A [mm]	B [mm]	C [mm]
	pcs	60	10	0,15	0,60	AA274020000	BA274020000	WA274020000	20	30	14,5	76,0	26
	pcs	40	10	0,21	0,60	AA274025000	BA274025000	WA274025000	25	37	16,0	83,5	35
	pcs	30	5	0,32	0,96	AA274032000	BA274032000	WA274032000	32	46	18,0	94,0	38
	pcs	20	2	0,40	1,07	AA274040000	BA274040000	WA274040000	40	60	20,5	107,0	38
	pcs	10	0	0,75	1,92	AA274050000	BA274050000	WA274050000	50	71	23,5	135,0	56
	pcs	6	0	1,29	2,10	AA274063000	BA274063000	WA274063000	63	84	27,5	160,0	60

FV PPR straight-way valve with PV valve

System: **FV AQUA**
 Material: PPR - brass
 Standard: ČSN EN ISO 15874, DIN 8077, DIN 8078
 Details: A valve allowing closing or regulation of the flow of water, see note* page 39

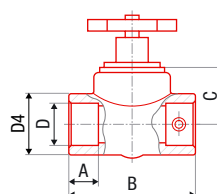

Icon	⊕	⊞	⊞	⊞	⊞	# ●	# ●	# ●*1	D [mm]	D4 [mm]	A [mm]	B [mm]	C [mm]
	pcs	50	10	0,17	0,60	AA275020000	BA275020000	WA275020000	20	30	14,5	76,0	26
	pcs	40	10	0,24	0,60	AA275025000	BA275025000	WA275025000	25	37	16,0	83,5	35
	pcs	30	2	0,35	0,96	AA275032000	BA275032000	WA275032000	32	46	18,0	94,0	38
	pcs	20	2	0,42	1,07	AA275040000	BA275040000	WA275040000	40	60	20,5	107,0	38

FV PPR angle straight-way valve

System: **FV AQUA**
 Material: PPR - brass
 Standard: ČSN EN ISO 15874, DIN 8077, DIN 8078
 Details: A valve allowing closing or regulation of the flow of water.

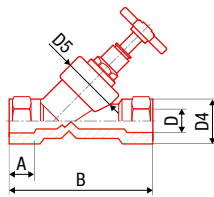

										D [mm]	D4 [mm]	D5 [mm]	A [mm]	B [mm]
20	pcs	50	1	0,19	0,25	AA277020000	BA277020000	WA277020000		20	35,3	46,8	14,5	83,6
25	pcs	40	1	0,16	0,56	AA277025000	BA277025000	WA277025000		25	35,3	46,8	16,0	83,6

FV PPR angle straight-way valve with PV valve

System: **FV AQUA**
 Material: PPR - brass
 Standard: ČSN EN ISO 15874, DIN 8077, DIN 8078
 Details: A valve allowing closing or regulation of the flow of water, see note* page 39

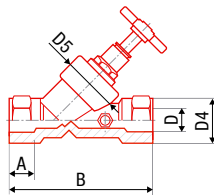

										D [mm]	D4 [mm]	D5 [mm]	A [mm]	B [mm]
20	pcs	50	1	0,19	0,25	AA278020000	BA278020000	WA278020000		20	35,3	46,8	14,5	83,6
25	pcs	40	1	0,16	0,56	AA278025000	BA278025000	WA278025000		25	35,3	46,8	16,0	83,6

FV PPR angle straight-way valve with back flow

System: **FV AQUA**
 Material: PPR - brass
 Standard: ČSN EN ISO 15874, DIN 8077, DIN 8078
 Details: A valve allowing closing or regulation of the flow of water.

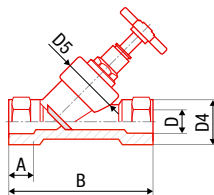

										D [mm]	D4 [mm]	D5 [mm]	A [mm]	B [mm]
20	pcs	50	1	0,19	0,25	AA279020000	BA279020000	WA279020000		20	35,3	46,8	14,5	83,6
25	pcs	40	1	0,16	0,56	AA279025000	BA279025000	WA279025000		25	35,3	46,8	16,0	83,6

FV PPR back flow valve

System: **FV AQUA**
 Material: PPR - brass
 Standard: ČSN EN ISO 15874, DIN 8077, DIN 8078
 Details: For prevention of back flow.

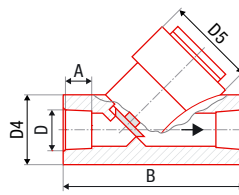

										D [mm]	D4 [mm]	D5 [mm]	A [mm]	B [mm]
20	pcs	40	1	0,19	0,25	AA281020000	BA281020000	WA281020000		20	35,3	46,8	14,5	83,6
25	pcs	40	1	0,19	0,25	AA281025000	BA281025000	WA281025000		25	35,3	46,8	16,0	83,6
32	pcs	40	1	0,16	0,56	AA281032000	BA281032000	WA281032000		32	42,0	46,8	18,0	94,0

FV PPR filter

System: **FV AQUA**
 Material: PPR - brass
 Standard: ČSN EN ISO 15874, DIN 8077, DIN 8078
 Details: Combined fitting with stainless strainer.

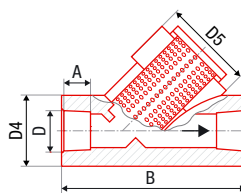

Icon	⊕	⊞	⊞	📦	dm ³	# ●	# ●	# ●*1	D [mm]	D4 [mm]	D5 [mm]	A [mm]	B [mm]	
	20	pcs	40	1	0,17	0,36	AA282020000	BA282020000	WA282020000	20	35,3	46,8	14,5	83,6
	25	pcs	40	1	0,17	0,36	AA282025000	BA282025000	WA282025000	25	35,3	46,8	16,0	83,6
	32	pcs	40	1	0,25	0,54	AA282032000	BA282032000	WA282032000	32	42,0	46,8	18,0	94,0

FV PPR shut off valve lux straight with chrome handle

System: **FV AQUA**
 Material: PPR - brass
 Standard: ČSN EN ISO 15874, DIN 8077, DIN 8078
 Details: An elegant above-plaster valve for closing branches of a distribution system.

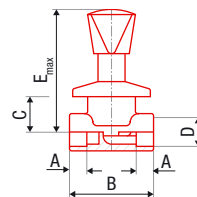

Icon	⊕	⊞	⊞	📦	dm ³	# ●	# ●	# ●*1	D, D4 [mm]	A [mm]	B [mm]	C [mm]	E_max [mm]
	20	pcs	15	1	0,25	AA285020000	BA285020000	WA285020000	20/36	14,5	76,0	26	105
	25	pcs	12	1	0,30	AA285025000	BA285025000	WA285025000	25/37,3	16,0	83,5	35	115

FV PPR shut off valve straight with cover

System: **FV AQUA**
 Material: PPR - brass
 Standard: ČSN EN ISO 15874, DIN 8077, DIN 8078
 Details: An elegant above-plaster valve for closing branches of a distribution system. 20* short v. (51 mm) 20L* long v. (69 mm)

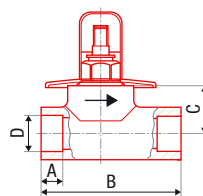

Icon	⊕	⊞	⊞	📦	dm ³	# ●	# ●	# ●*1		D [mm]	A [mm]	B [mm]	C [mm]
	20*	pcs	20	1	0,17	AA286020000	BA286020000	WA286020000	metal cover	20	15	75,6	26
	20L*	pcs	20	1	0,17	AA286020100	BA286020100	WA286020100	metal cover	20	15	75,6	25
	25	pcs	15	1	0,21	AA286025000	BA286025000	WA286025000	metal cover	25	16	83,3	36
	25L	pcs	15	1	0,21	AA286025100	BA286025100	WA286025100	metal cover	25	16	83,3	35
	20	pcs	20	1	0,17	AA287020000	BA287020000	WA287020000	plastic cover	20	15	75,6	26
	20L	pcs	20	1	0,17	AA287020100	BA287020100	WA287020100	plastic cover	20	15	75,6	26
	25	pcs	15	1	0,21	AA287025000	BA287025000	WA287025000	plastic cover	25	16	83,3	34
	25L	pcs	15	1	0,21	AA287025100	BA287025100	WA287025100	plastic cover	25	16	83,3	36

FV PPR inside the valve

System: **FV AQUA**
 Material: brass
 Standard: ČSN EN ISO 15874, DIN 8077, DIN 8078
 Details: Spare part for straight-way valve.
 Note: Spare parts for all type of straight-way valve and shut off valve. For order please contact our sales department.



Icon	⊕	⊞	⊞	📦	dm ³	#	D [mm]	description
	20	pcs		1		AA288020001	20	short d32
	20	pcs		1		AA288020002	20	long (laguna) d20
	25	pcs		1		AA288025001	25	short d32
	25	pcs		1		AA288025002	25	long (laguna) d20
	32	pcs		1		AA288032001	32	short d32

FV PP-RCT FITTINGS FOR BUT WELDING

FV PP-RCT butt welding elbow 90°

System: **FV AQUA**
 Material: PP-RCT
 Standard: ČSN EN ISO 15874, DIN 8077, DIN 8078
 Details: A simple, reliable fitting for changing the pipeline direction. SDR 11.

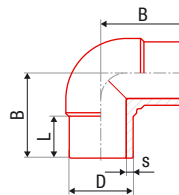

Icon	⊕	⊞	⊞	⊞	⊞	#	D [mm]	B [mm]	s [mm]	L [mm]	
	160	pcs	1	1	3,0	9	BA202160000	160	212	14,6	110
	200	pcs	1	1	5,4	20	BA202200000	200	255	18,2	127
	250	pcs	1	1	9,5	30	BA202250000	250	294	22,7	140

FV PP-RCT butt welding elbow 45°

System: **FV AQUA**
 Material: PP-RCT
 Standard: ČSN EN ISO 15874, DIN 8077, DIN 8078
 Details: A simple, reliable fitting for changing the pipeline direction. SDR 11.

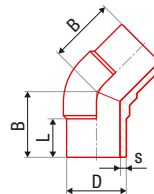

Icon	⊕	⊞	⊞	⊞	⊞	#	D [mm]	B [mm]	s [mm]	L [mm]	
	160	pcs	1	1	2,42	7	BA203160000	160	168	14,6	110
	200	pcs	1	1	4,44	16	BA203200000	200	217	18,2	127
	250	pcs	1	1	7,66	25	BA203250000	250	223	22,7	140

FV PP-RCT butt welding reduction

System: **FV AQUA**
 Material: PP-RCT
 Standard: ČSN EN ISO 15874, DIN 8077, DIN 8078
 Details: A simple, reliable fitting for dimension change of pipeline. SDR 11.

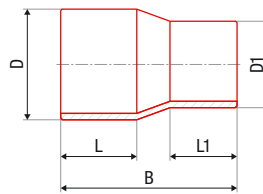

Icon	⊕	⊞	⊞	⊞	⊞	#	D [mm]	D1 [mm]	B [mm]	L [mm]	L1 [mm]	
	160 × 110	pcs		1	1,14	5	BA210160110	160	110	255	110	93
	160 × 125	pcs		1	1,16	5	BA210160125	160	125	255	110	97
	200 × 160	pcs		1	2,61	9	BA210200160	200	160	275	122	100
	250 × 160	pcs		1	3,95	14	BA210250160	250	160	330	137	111
	250 × 200	pcs		1	4,45	15	BA210250200	250	200	330	137	128

FV PP-RCT electro-fusion socket

System: **FV AQUA**
 Material: PP-RCT
 Standard: ČSN EN ISO 15874, DIN 8077, DIN 8078
 Details: A fitting for pipe connection under electro-fusion welding condition. SDR 11.

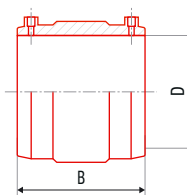

Icon	⊕	⊞	⊞	⊞	⊞	#	D [mm]	B [mm]	
	160	pcs		1	1,82	5	BA234160000	160	175
	200	pcs		1	2,58	9	BA234200000	200	185
	250	pcs		1	4,42	14	BA234250000	250	213

FV PP-RCT butt welding tee

System: **FV AQUA**
 Material: PP-RCT
 Standard: ČSN EN ISO 15874, DIN 8077, DIN 8078
 Details: A simple, reliable fitting for branching the pipeline.
 SDR 11.

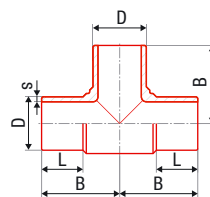

Objekt	Symbol	Skupina	Podskupina	Objem	Objem [dm ³]	#	D [mm]	B [mm]	s [mm]	L [mm]
160	pcs		1	3,99	12	BA208160000	160	225	14,6	124
200	pcs		1	7,38	18	BA208200000	200	251	18,2	127
250	pcs		1	9,80	23	BA208250000	250	314	22,7	148

FV PP-RCT polyfusion/butt welding tee reduced

System: **FV AQUA**
 Material: PP-RCT
 Standard: ČSN EN ISO 15874, DIN 8077, DIN 8078
 Details: A simple, reliable fitting for branching the pipeline.
 SDR 11.

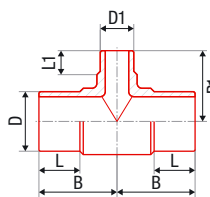

Objekt	Symbol	Skupina	Podskupina	Objem	Objem [dm ³]	#	D [mm]	D1 [mm]	B [mm]	L [mm]	L1 [mm]
160 × 90 × 160	pcs		1	3,20	9	BA212160090	160	90	212	110	85
160 × 110 × 160	pcs		1	3,34	10	BA212160110	160	110	212	110	95
200 × 90 × 200	pcs		1	6,20	14	BA212200090	200	90	255	127	95
200 × 110 × 200	pcs		1	6,40	15	BA212200110	200	110	255	127	95
200 × 125 × 200	pcs		1	6,80	16	BA212200125	200	125	255	127	100
200 × 160 × 200	pcs		1	7,12	17	BA212200160	200	160	255	127	110

FV PP-RCT butt welding blinding

System: **FV AQUA**
 Material: PP-RCT
 Standard: ČSN EN ISO 15874, DIN 8077, DIN 8078
 Details: For permanent or temporary blinding of a branch.
 SDR 11.

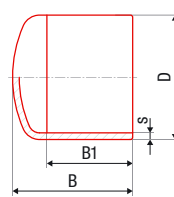

Objekt	Symbol	Skupina	Podskupina	Objem	Objem [dm ³]	#	D [mm]	s [mm]	B [mm]	B1 [mm]
160	pcs		1	0,90	2,9	BA229160000	160	14,6	140	100
200	pcs		1	2,03	6,2	BA229200000	200	18,2	190	145
250	pcs		1	3,18	12,7	BA229250000	250	22,7	218	263

FV PP-RCT weld in saddle polyfusion

System: **FV AQUA**
 Material: PP-RCT
 Standard: ČSN EN ISO 15874, DIN 8077, DIN 8078
 Details: For additional branches from existing pipeline.
 SDR 11.
 * Diameter hole is drilled to the desired diameter D1 of branch.

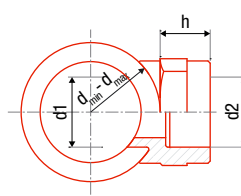

Objekt	Symbol	Skupina	Podskupina	Objem	Objem [dm ³]	#	d _{min} [mm]	d _{max} [mm]	d1 [mm]	d2 [mm]	h [mm]
125 × 32	pcs		1	0,04	0,4	BA238125032	75	125	32	32	35
125 × 40	pcs		1	0,04	0,4	BA238125040	75	125	40	40	38
125 × 50	pcs		1	0,04	0,4	BA238125050	110	125	50	50	39
125 × 63	pcs		1	0,04	0,4	BA238125063	125	125	63	63	45
160 - 250 × 20	pcs		1	0,04	0,4	BA238160020	160	250	20	20	29
160 - 250 × 25	pcs		1	0,04	0,4	BA238160025	160	250	25	25	29
160 - 250 × 32	pcs		1	0,04	0,4	BA238160032	160	250	32	32	35
160 - 250 × 40	pcs		1	0,04	0,4	BA238160040	160	250	40	40	38
160 - 250 × 50	pcs		1	0,04	0,4	BA238160050	160	250	50	50	39
160 - 250 × 63	pcs		1	0,04	0,4	BA238160063	160	125	63	63	45

FV PP-RCT weld in saddle with metal male thread polyfusion

System: **FV AQUA**
 Material: PP-RCT - brass
 Standard: ČSN EN ISO 15874, DIN 8077, DIN 8078
 Details: Transition fitting from plastic part to metal part of pipeline, for additional branches.

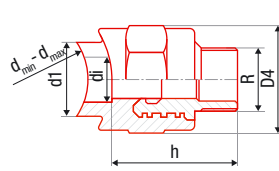

Objekt	Symbol	Skupina	Podskupina	Objekt	Objekt	#	d _{min} [mm]	d _{max} [mm]	d1 [mm]	R	h [mm]	di [mm]	D4 [mm]
160 - 250 × 25 × 1/2"	pcs	1	1	0,132	0,048	BM248160025	160	250	25	1/2"	42	15	38
160 - 250 × 32 × 3/4"	pcs	1	1	0,116	0,100	BM248160032	160	250	32	3/4"	49	20,5	51
160 - 250 × 40 × 1"	pcs	1	1	0,234	0,168	BM248160040	160	250	40	1"	54	25,5	63
160 - 250 × 40 × 5/4"	pcs	1	1	0,234	0,168	BM248160041	160	250	40	1 1/4"	54	25,5	63
160 - 250 × 50 × 5/4"	pcs	1	1	0,330	0,227	BM248160050	160	250	50	1 1/4"	59	32	70
160 - 250 × 50 × 6/4"	pcs	1	1	0,350	0,227	BM248160051	160	250	50	1 1/2"	59	34	70
160 - 250 × 63 × 2"	pcs	1	1	0,632	0,255	BM248160063	160	250	63	2"	45	40	85

FV PP-RCT weld in saddle with metal female thread polyfusion

System: **FV AQUA**
 Material: PP-RCT - brass
 Standard: ČSN EN ISO 15874, DIN 8077, DIN 8078
 Details: Transition fitting from plastic part to metal part of pipeline, for additional branches.

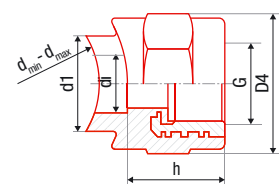

Objekt	Symbol	Skupina	Podskupina	Objekt	Objekt	#	d _{min} [mm]	d _{max} [mm]	d1 [mm]	G	h [mm]	di [mm]	D4 [mm]
160 - 250 × 25 × 1/2"	pcs	1	1	0,060	0,03	BM247160025	160	250	25	1/2"	29	15	38
160 - 250 × 32 × 3/4"	pcs	1	1	0,102	0,07	BM247160032	160	250	32	3/4"	35	20,5	51
160 - 250 × 40 × 1"	pcs	1	1	0,194	0,12	BM247160040	160	250	40	1"	38	25,5	63
160 - 250 × 40 × 5/4"	pcs	1	1	0,194	0,12	BM247160041	160	250	40	1 1/4"	38	25,5	63
160 - 250 × 50 × 5/4"	pcs	1	1	0,240	0,15	BM247160050	160	250	50	1 1/4"	39	32	70
160 - 250 × 50 × 6/4"	pcs	1	1	0,244	0,15	BM247160051	160	250	50	1 1/2"	39	34	70
160 - 250 × 63 × 2"	pcs	1	1	0,490	0,26	BM247160063	160	250	63	2	45	40	85

FV PP-RCT butt welding flange adaptor

System: **FV AQUA**
 Material: PP-RCT
 Standard: ČSN EN ISO 15874, DIN 8077, DIN 8078
 Details: FV PP-RCT butt welding flange adaptor

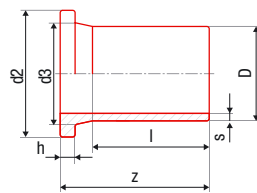

Objekt	Symbol	Skupina	Podskupina	Objekt	Objekt	#	D [mm]	l [mm]	z [mm]	d2 [mm]	d3 [mm]	h [mm]	s [mm]
160/150	pcs		1	1,59	6,64	BA230160150	160	110	175	212	175	25	14,6
200/200	pcs		1	3,00	11,56	BA230200200	200	127	205	268	232	32	18,2
250/250	pcs		1	5,02	18,90	BA230250250	250	146	235	320	285	35	22,7

FV PP-RCT flange

System: **FV AQUA**
 Material: PP coated steel
 Standard: ČSN EN ISO 15874, DIN 8077, DIN 8078
 Details: Metal fitting for flange dismountable joints.

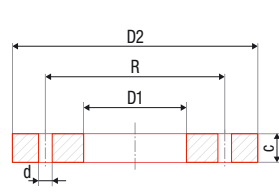

Objekt	Symbol	Skupina	Podskupina	Objekt	Objekt	#	D1 [mm]	D2 [mm]	R [mm]	c [mm]	d	number of holes
160/150	pcs	1	1	2,80	1,53	BA231160150	178	285	240	24	M16	8
200/200	pcs	1	1	3,77	2,18	BA231200200	235	340	295	24	M16	8
250/250	pcs	1	1	6,04	4,01	BA231250250	288	406	350	31	M16	12

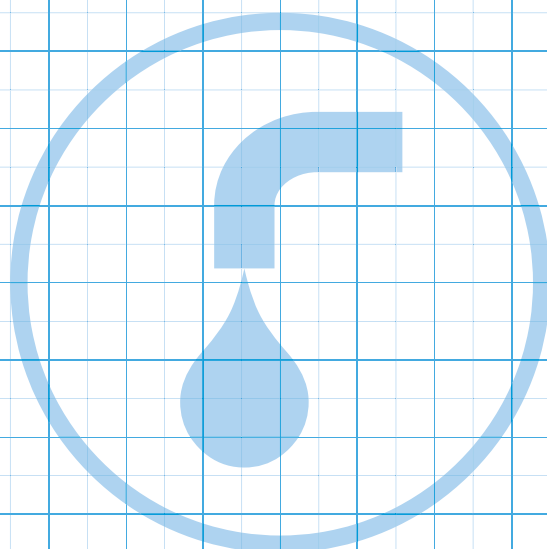



FV SM 21



FV SM 41



FV SE 21



FV SE 41

TOOLS SUITABLE FOR FV AQUA PPR AND PP-RCT

Welding machine 650 W for non-paired adapter $\varnothing 16 - \varnothing 63$

Welding machine for non-paired adapter, manual adjustment (SM 21), electronics adjustment (SE 21)
The most favourite welding machine developed by FV-Plast, a.s., especially the model SM 21 with direct control. Offered also as a set with a case.

Icon	⊕	⊞	⊠	⊡	⊣	#	P [W]	
SM 21	pcs	1	1	1,28	6,14	AA401001650	650	thermostat
SE 21	pcs	1	1	1,28	6,14	AA401002650	650	electronic regulation



Welding machine 850 W for paired adapter $\varnothing 16 - \varnothing 75$

New generation of welding machine for paired adapter, manual adjustment (SM 41), electronics adj. (SE 41).
An efficient welding machine developed by FV-Plast, a.s. Quality workmanship, quality components, professional design, including durable power cord. The SE 41 is equipped with precise electronic regulation. Suitable for welding of larger pipe diameters, fast heat up time.

Icon	⊕	⊞	⊠	⊡	⊣	#	P [W]	
SM 41	pcs	1	1	1,32	6,14	AA402001850	850	thermostat
SE 41	pcs	1	1	1,32	6,14	AA402002850	850	electronic regulation



Dytron Welder Polys P-4 650 W

A welding machine by a renowned Czech producer.

Icon	⊕	⊞	⊠	⊡	⊣	#	P [W]	
P-4a	pcs	1	1	1,60	6,21	AA403001650	650	thermostat
P-4b	pcs	1	1	2,00	6,21	AA403002650	650	electronic regulation



Dytron Welder Polys P-4 850 W

A welding machine by a renowned Czech producer.

Icon	⊕	⊞	⊠	⊡	⊣	#	P [W]	
P-4a	pcs	1	1	2,00	6,21	AA404001850	850	electronic regulation



Dytron Welder Polys P-4 1200 W

A welding machine by a renowned Czech producer.

Icon	⊕	⊞	⊠	⊡	⊣	#	P [W]	
P-4a	pcs	1	1	2,10	6,21	AA405001120	1200	electronic regulation



Dytron Welder Polys P-1b 500 W

A welding machine by a renowned Czech producer, suitable also for welding in installation shafts.



P-1b	pcs	1	1	1,6	6,21	AA406001500	500	thermostat

Mini set SM 21

Practical set for socket welding designed for hobbyists and unpretentious Professionals. Traditional metal case please durability and welder his life. Contents: thorns welder SM 21, jaw adaptors ø 20, 25 and 32 mm, metal case MINI, scissors, stand, 4 mm Allen key.



SM 21	set	1	1	5,12	8,52	AA407000000	650	thermostat



Mini set SM 41

Practical set for socket welding designed for hobbyists and unpretentious Professionals. Traditional metal case please durability and welder his life. Contents: flat welder SM 41, jaw adaptors ø 20, 25, 32 and 40 mm, metal case MINI, scissors, stand, 6 mm Allen key.



SM 41	set	1	1	5,40	8,52	AA408000000	850	thermostat
SE 41	set	1	1	5,40	8,52	AA408001000	850	electronic regulation



Profi set SE 21

Practical professional set for socket welding designed for all-day use in the most demanding craftsmen. Robust metal suitcase please durability and welder his life. Contents: 21 SE thorns welder, jaw adaptors ø 16, 20, 25, 32, 40, 50, 63 mm metal case PROFI, foot stand, scissors DYNO, 4 mm Allen key.



SE 21	set	1	1	8,26	16,58	AA409000000	650	electronic regulation



Profi set SE 41

Practical professional set for socket welding designed for all-day use in the most demanding craftsmen. Robust metal case please durability and welder his life. Contents: 41 SE thorns welder, jaw adaptors ø 16, 20, 25, 32, 40, 50, 63 mm metal case PROFI, foot stand, scissors DYNO, 6 mm Allen key.



SE 41	set	1	1	8,30	16,58	AA410000000	850	electronic regulation



Adapter paired for SM 41 and SE 41 black

Pair adapter can only be used for flat welder. Allow welding of pipes from the lowest d16 to the diameter d125. Depending on the size can be fitted to the welder suddenly one to two adapters.

DN	set	1	1	mm	mm	#
16	set	1	1	0,06	0,03	AA411016000
20	set	1	1	0,06	0,03	AA411020000
25	set	1	1	0,10	0,06	AA411025000
32	set	1	1	0,18	0,10	AA411032000
40	set	1	1	0,23	0,14	AA411040000
50	set	1	1	0,34	0,20	AA411050000
63	set	1	1	0,63	0,32	AA411063000
75	set	1	1	0,84	0,45	AA411075000
90	set	1	1	1,52	0,73	AA411090000
110	set	1	1	1,70	1,69	AA411110000
125	set	1	1	1,92	2,13	AA411125000



Adapter paired for SM 41 and SE 41 blue

Pair adapter can only be used for flat welder. Allow welding of pipes from the lowest d20 to the diameter d110. Depending on the size can be fitted to the welder suddenly one to two adapters.

DN	set	1	1	mm	mm	#
20	set	1	1	0,06	0,03	AA411020001
25	set	1	1	0,10	0,06	AA411025001
32	set	1	1	0,18	0,10	AA411032001
40	set	1	1	0,23	0,14	AA411040001
50	set	1	1	0,34	0,20	AA411050001
63	set	1	1	0,63	0,32	AA411063001
75	set	1	1	0,84	0,45	AA411075001
90	set	1	1	1,52	0,73	AA411090001
110	set	1	1	1,70	1,69	AA411110001



Adapter paired for weld in saddle

Pair adapters can only be used for flat welder. Allow welding additional seats branches from d25 to d63 to pipe from d63 to d250. Depending on the size can be fitted to the welder suddenly one to two adapters.

DN	set	1	1	mm	mm	#
63 × 32	set	1	1	0,300	0,137	AA412063032
75 × 32	set	1	1	0,300	0,137	AA412075032
90 × 32	set	1	1	0,300	0,137	AA412090032
110 × 32	set	1	1	0,300	0,137	AA412110032
110 × 40	set	1	1	0,300	0,137	AA412110040
75 - 125 × 25	set	1	1	0,280	0,655	AA412125025
75 - 125 × 32	set	1	1	0,410	0,655	AA412125032
75 - 125 × 40	set	1	1	0,230	0,655	AA412125040
75 - 125 × 50	set	1	1	0,230	0,655	AA412125050
75 - 125 × 63	set	1	1	1,164	2,639	AA412125063
160 - 250 × 25	set	1	1	0,170	0,160	AA412160025
160 - 250 × 32	set	1	1	0,230	0,160	AA412160032
160 - 250 × 40	set	1	1	0,360	0,160	AA412160040
160 - 250 × 50	set	1	1	0,650	0,160	AA412160050
160 - 250 × 63	set	1	1	1,040	0,160	AA412160063



Drill for weld in saddle

Special drill for perfect drilling of holes in the main pipe to mount weld-in saddles of all types. Necessary tools to create the correct hole.

Ø _{ext}	⊕	⊞	⊠	📏	dm ³	#
25	pcs	1	1	0,164	0,10	AA414025000
32	pcs	1	1	0,228	0,10	AA414032000
40	pcs	1	1	0,256	1,10	AA414040000
50	pcs	1	1	0,347	0,46	AA414050000
63	pcs	1	1	0,466	0,46	AA414063000



Adapter non-paired for SM 21 and SE 21 black

Jaw adapters can only be used for a rod type welders. Allow welding of pipes from the lowest diameters d16 to d63. Depending on the size can be fitted to the welder suddenly one to three extensions.

Ø _{ext}	⊕	⊞	⊠	📏	dm ³	#
16	pcs	1	1	0,13	0,13	AA415016000
20	pcs	1	1	0,15	0,15	AA415020000
25	pcs	1	1	0,16	0,19	AA415025000
32	pcs	1	1	0,17	0,30	AA415032000
40	pcs	1	1	0,30	0,41	AA415040000
50	pcs	1	1	0,40	0,57	AA415050000
63	pcs	1	1	0,77	0,85	AA415063000



Adapter non-paired for SM 21 and SE 21 blue

Jaw adapters can only be used for a rod type welders. Allow welding of pipes from the lowest diameters d16 to d63. Depending on the size can be fitted to the welder suddenly one to three extensions.

Ø _{ext}	⊕	⊞	⊠	📏	dm ³	#
16	pcs	1	1	0,13	0,13	AA415016001
20	pcs	1	1	0,11	0,15	AA415020001
25	pcs	1	1	0,14	0,19	AA415025001
32	pcs	1	1	0,22	0,30	AA415032001
40	pcs	1	1	0,325	0,41	AA415040001
50	pcs	1	1	0,480	0,57	AA415050001
63	pcs	1	1	0,725	0,85	AA415063001



Repairing set

A set for fast and reliable repairs of drill-damaged distribution systems. Allows easy repair pipes due to unintentional drilling without changing the pipe in the wall. Can only be used with a rod welders. Before use, inspect instructional video.

Ø _{ext}	⊕	⊞	⊠	📏	dm ³	#
	set	1	1	0,20		AA418000000



Repairing stake

Expendable supplies for a repair set.

Ø _{ext}	⊕	⊞	⊠	📏	dm ³	#
	set	1	5	0,03		AA419000000



STABIOXY pipes shaver

Essentially accurate, calibratable tool designed to remove the top layer of plastic and aluminum foil before welding pipes STABIOXY. Always two dimensions in a single instrument. Quality carbide blades. Before the first use, it is necessary to calibrate onto pipe PPR CLASSIC.

mm	pcs	mm	mm	mm	mm	#
16 - 20	pcs	1	1	0,15	0,19	AA420016020
20 - 25	pcs	1	1	0,19	0,19	AA420020025
25 - 32	pcs	1	1	0,23	0,25	AA420025032
32 - 40	pcs	1	1	0,24	0,30	AA420032040
50	pcs	1	1	0,20	0,30	AA420050000
63	pcs	1	1	0,30	0,42	AA420063000
75	pcs	1	1	0,34	0,57	AA420075000
90	pcs	1	1	0,66	0,91	AA420090000
110	pcs	1	1	0,72	1,33	AA420110000



Shavers to drill machine for STABIOXY pipes

Essentially accurate, calibratable tool for attachment to the drill. It is designed to remove the top layer of plastic and aluminum foil before welding pipes STABIOXY. Quality carbide blades. Before the first use, it is necessary to calibrate onto pipe PPR CLASSIC.

mm	pcs	mm	mm	mm	mm	#
16	pcs	1	1	0,15	0,19	AA421016000
20	pcs	1	1	0,19	0,19	AA421020000
25	pcs	1	1	0,23	0,25	AA421025000
32	pcs	1	1	0,24	0,30	AA421032000
40	pcs	1	1	0,20	0,30	AA421040000
50	pcs	1	1	0,30	0,42	AA421050000
63	pcs	1	1	0,72	1,33	AA421063000



Cordless pipe shears d40

Cordless pipe shears for fast, effortless cutting of plastic and multi-layer pipes $\varnothing \leq 40$ mm, $\varnothing \leq 15/8"$. Quality NiMh battery gives up to 40 minutes of work, or 400 cuts per charge.

mm	pcs	mm	mm	mm	mm	#
	pcs	1	1	1,57	8,00	AA422000000



Pipe cutter REMS

A quality tool for reliable separation of pipes with larger dimensions.

mm	pcs	mm	mm	mm	mm	#
d50 - 110	pcs	1	1	1,20	3,65	AA423000000



Shears

Quality tested tools with sufficient performance and comfort for professional cutting of PPR, PP-RCT, PE-RT, HDPE and PEX pipes of all supplied dimensions.

						#
M1 d32	pcs	15	1	0,34	0,96	AA424032000
M5 d40	pcs	10	1	0,42	0,96	AA424040000
M4 d63	pcs	2	1	1,17	3,17	AA424063000



illustrative photo

Tightening spanner with belt

A tool for safe tightening of plastic nuts. Essential tool for proper fixation and tightening fittings containing a plastic with brass thread.

						#
	pcs	20	1	0,33	0,72	AA425000000



Spiral for sewer cleaning

Practical helper of each plumber.

						#
2,5 m	pcs	1	1	0,64	1,88	AA426000003
5,0 m	pcs	1	1	1,21	2,50	AA426000005
10,0 m	pcs	1	1	4,73	6,48	AA426000010
20,0 m	pcs	1	1	9,40	10,11	AA426000020
25,0 m	pcs	1	1	11,93	11,55	AA426000025



Assembly MP 75

Light fixation apparatus operated by a lever, with infinitely adjustable clamping jaws provide a firm grip and mutual welding fittings and pipes with 40-75 mm. The advantage of this device is a low weight, which can be further reduced by removing the clamping jaws, it is therefore advantageous with this device works in positional welds, e.g. under the ceiling.

						#
40 - 75	pcs	1	1	22,00	160,00	AA427040075



Assembly MP 110 UD

Robust professional equipment designed for socket welding of pipes and fittings up to dimension 110mm. The set comes with a set of necessary accessories, which is stored in a practical case. As a special accessory can be ordered reduction inserts for the STABIOXY pipes. Set includes: clamping slide (including selected fixtures) welder POLYS P-4a 1250 W, paired adapters of DT coatings 40, 50, 63, 75, 90 and 110 mm, inserts according to the selected design, stand welder, centering pin, clamping inserts, metal case for accessories, allen keys 5, 6, 8 mm.

						#
40 - 110	pcs	1	1	47,00	240,00	AA428040110



Spider 125 with universal clamping

The spider is lightweight ideal equipment for quick and accurate socket fusion of polypropylene pipe and fittings from 63 mm to 125 mm. The spider is delivered in a robust, rugged stainless steel or plastic case. The product itself has a low weight, only 7,5 kg. The Spider is ideal for performing socket fusions overhead, vertically and other tight indoor spaces from the attic to the floor.

Note: The green stand is not included. It can be ordered separately under the name Spider Demo stand .

						
39 x 51 x 24 cm	pcs	1	1	14,6	47,74	AA428050125



Spider Demo stand

Holds Spider 125 for demo purposes. Practical holder for a mounting welding tool that is solid, precise and very stable despite its low weight. The advantage is easy and fast fastening and welding on the table or on the ground.

						
37 x 30 x 5,5 cm	pcs	1	1	4,90	6,11	AA428050300



Case for welding machine type PROFI







If you decide to build your PROFI kit for socket welding gradually, a rugged metal case will be suitable.

						
PROFI SE 21	pcs	1	1	4,8	16,9	AA417001000
PROFI SE 41	pcs	1	1	4,8	16,9	AA417002000



Case for welding machine type MINI

If you decide to build your MINI kit for socket welding gradually, a rugged metal case will be suitable.

						
MINI SM 21	pcs	1	1	2,9	9,09	AA417003000
MINI SM 41	pcs	1	1	2,9	9,09	AA417004000



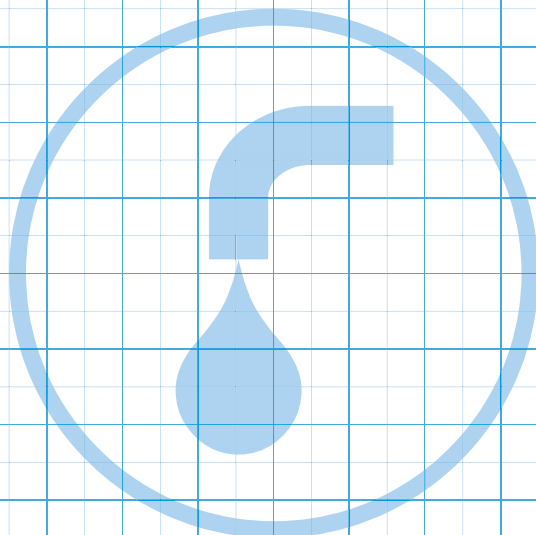

FV
PLAST®

PN20



ASSEMBLY INSTRUCTION FOR FV AQUA PPR AND PP-RCT

1. USE OF THE SYSTEM

System FV AQUA PPR and PP-RCT enables distribution implementations in residential houses, administrative and public buildings, in industry and agriculture.

It is intended for delivery of cold and hot water and also for central heating, provided that the prescribed rules are met. It is necessary to select suitable kind of pipes with corresponding parameters of limit operating temperature and pressure. The system FV AQUA offers pipes PPR, PPR-RCT HOT, PP-RCT UNI, FASER and STABIOXY.

The system can also be used for air distributions. A possibility of leading other liquids, gases or solids needs to be assessed individually in every particular example.

All pipes can be connected by a complete range of PPR pipe fittings by a polyfusion welding (up to the diameter of 125 mm) or by butt welding (diameters beyond 160 mm).

Water distributions

The system can be used for all inner water piping systems (cold drinking water, cold service water, hot water, circulation). An expected lifespan for a plastic piping system is 50 years providing the right material, type of a piping and correct implementation.

Type of a pipe according to the system of the hot water heating and its temperature regulation is selected by a project architect. In the case of hot water distribution, the expected maximum water temperature at the outflow tap is 57 °C as a protection against scalding, and inside the distributions themselves, there is a possibility of short-term water overheating to higher temperatures (70 °C) at the point of heating due to the hygiene, mainly in order to eliminate pathological organisms.

Heating distributions

When considering the suitability of a particular type of piping for heating, it is necessary to use the value of input calculating temperature of the heating water, which is the highest temperature that is reached in the system. A project architect of the heating system chooses it depending on the required temperature at the input of the heating units, according to technical possibilities of the source of heat and the type of expansion vessel.

Recommended values for heating			
Temperature range			
70/50 °C	70/60 °C	75/65 °C	80/60 °C
And for low temperature systems			

During the installation of a plastic piping behind a boiler we recommend, with respect to protection against the system overheating, to install 1,5 m – 2. m of metal pipings behind the boiler.

Ways of leading of the pipings for water and heating distributions are identical. The basic requirements are securing of the mechanical protection of the piping and securing the support of the pipings and dilatation compensations.

Piping can be led:

- in the grooves of walls
- in installation dividers (prewall assembly)
- in floors and ceilings
- along the walls (freely or in covers)
- in installation shafts and sewerages
- under plaster
- in drywall and plasterboard ceilings

It is necessary to assess the leading of the piping outside the object according to specific conditions.

2. ASSEMBLY INSTRUCTION

2.1. Warning

During the assembly, it is only possible to use elements which were not damaged or polluted during the transport and storage.

In view of welding, the minimal temperature for the assembly of plastic distributions is +5 °C. At lower temperatures, it is difficult to ensure the conditions for the formation of quality links.

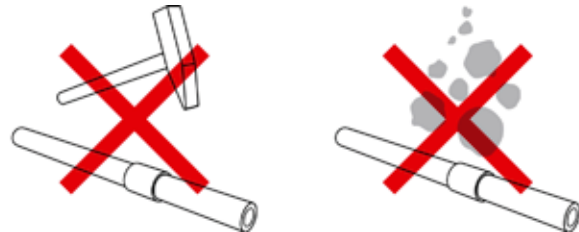

Over the whole course of assembly and transport, the elements of the plastic system must be protected against impact, shocks, falling material and other ways of mechanical damage.



Bending of a pipe is carried out without preheating at the temperature +15 °C minimum. For pipes of a diameter 16-32 mm, the minimal bending diameter is 8 times the diameter of the piping (D).

It is unacceptable to bend a pipe with the aid of heating with an open flame or with hot air.

Crossing of pipes is carried out by elements designed specifically for this purpose.

Connecting of plastic parts is carried out by polyfusion welding, and also by welding with electro pipe fittings and butt welding. In the process of welding, a high-quality homogeneous link arises. For connecting, it is necessary to observe the strict procedures and use appropriate tools.

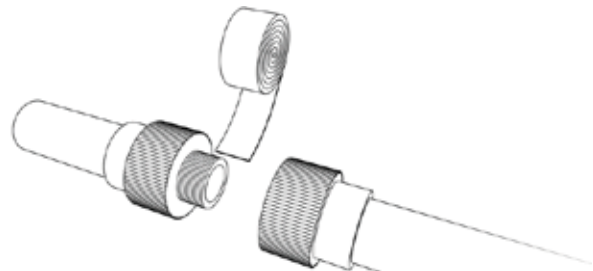

For threaded links, it is necessary to use pipe fittings with a thread. Cutting of threads on plastic elements is forbidden. Threads are sealed by Teflon tape, sealing thread or special sealants.

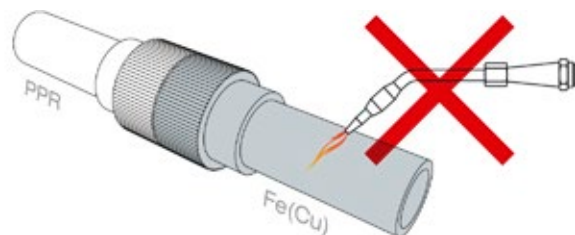

If a combined pipe fitting is followed by a metal pipe, it is not possible to connect the metal pipe in the vicinity of a pipe fitting by soldering or welding, because of possible heat transfer into the pipe fitting.

For closure of wall bends or alternatively of universal wall set before the assembly of outlet fixtures, we recommend to use plastic plugs (plastic plugs are intended only for a temporary use – e. g. pressure test). For long-term closure, plugs with a metal thread must be used.

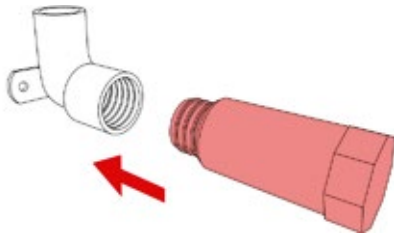

2.2 Longitudinal expansivity and contractivity

A temperature difference during the assembly and during the operation, when a medium with a different temperature than the assembly temperature is transported through the piping, causes longitudinal differences – lengthening or shortening (l).

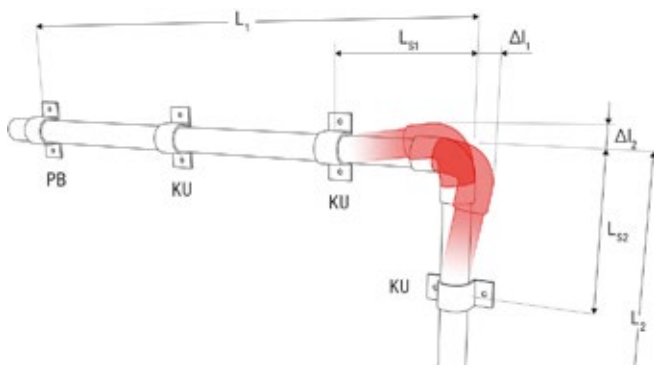

$$\Delta l = \alpha \cdot L \cdot t \text{ [mm]}$$

- Δl Longitudinal change [mm]
- α Coefficient of thermal longitudinal expansion [mm/m °C], for the all-plastic piping PPR design $\alpha = 0,15$ | for STABIOXY and FASER $\alpha = 0,05$
- L Calculating length (distance of two neighbouring fixed points in line) [m]
- t A temperature difference at assembly and at operation [°C]

$$L_s = k \cdot \sqrt[3]{(D \cdot \Delta l)} \text{ [mm]}$$

- L_s Free compensatory length
- k Material constant, for PPR $k = 20$
- D Outer diameter of piping [mm]
- Δl Longitudinal change [mm] calculated from the previous formula

U - compensator

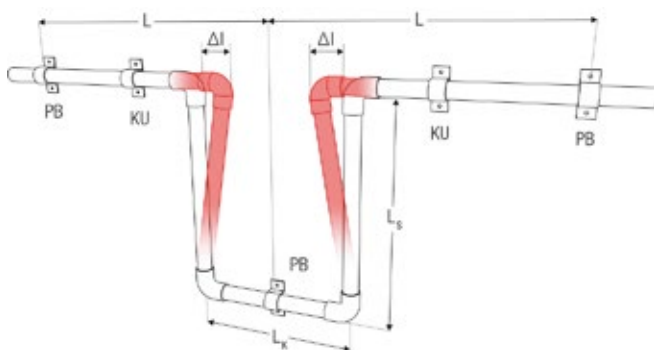

- PB Fixed point
- KU Sliding point
- L Calculating length of the piping
- L_s Compensatory length
- Δl Longitudinal change
- L_k Width of the compensator

$$L_k = 2 \cdot \Delta l + 150 \text{ [mm]} \text{ and also } Lk \geq 10 \cdot D$$

- L_k Width of the compensator
- Δl Longitudinal change [mm]
- D Outer diameter of piping

A suitable way of compensation: piping is deflected in the direction perpendicular to the original route and at this perpendicular, a free compensatory length (marked L) is left, which ensures that no significant additional pressure and tractional tensions arise in the wall of the piping. Compensatory length L_k depends on the calculated lengthening (shortening) of the route, material and the diameter of the piping. In the case of polypropylene, for compensation of longitudinal changes flexibility of the material is used. Apart from the compensation at the bending, bending "U" compensators and loop compensators are used.

The value of the longitudinal change and the value of the compensatory length can also be read from the graphs.

Table for installation of a compensation pipe

Piping diameter [mm]	Fixed points distance L [m]	
	FASER, STABIOXY	PPR and PP-RCT
16	24	8
20	27	9
25	30	10
32	36	12
40	42	14

Compensation pipe

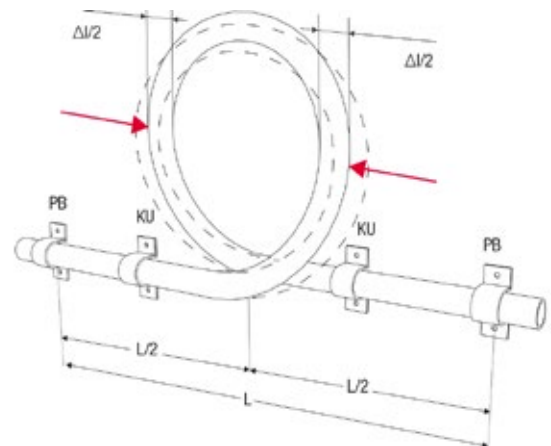

- PB Fixed point
- KU Sliding point
- L Calculating length of the piping

An example of a compensation by changing the route adapted to the building structure

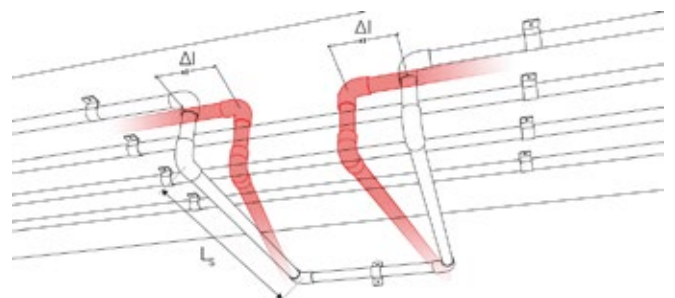

„U“ compensator

Calculated free length L means the length without any fixed supports or suspensions, which could impede the dilatation. Free length L should not exceed the maximum distance of supports according to the piping diameter and the temperature of the medium.

Longitudinal lengthening: an all-plastic piping PPR and PP-RCT

Example: L = 8 m, $\Delta t = 40^\circ\text{C}$

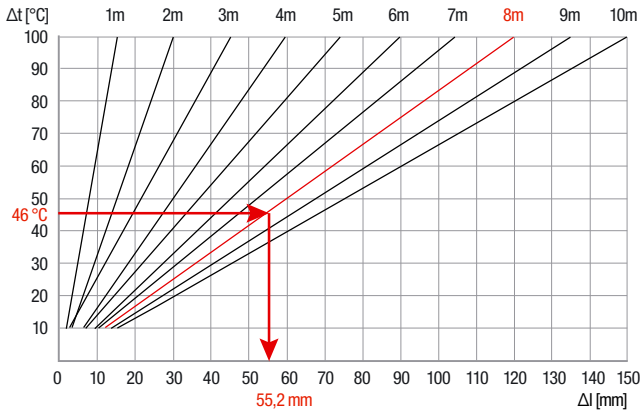

Length of piping [m]	Temperature difference Δt							
	10 °C	20 °C	30 °C	40 °C	50 °C	60 °C	70 °C	80 °C
	Length difference Δl [mm]							
1	1,5	3	5	6	8	9	11	12
2	3	6	9	12	15	18	21	24
3	5	9	14	18	23	27	32	36
4	5	9	14	18	23	27	32	36
5	8	15	23	30	38	45	53	60
6	9	18	27	36	45	54	63	72
7	11	21	32	42	53	63	74	84
8	12	24	36	48	60	72	84	96
9	14	27	41	54	68	81	95	108
10	15	30	45	60	75	90	105	120
15	23	45	68	90	113	135	158	150

Longitudinal lengthening: pipings STABIOXY and FASER

Example: L = 10 m, $\Delta t = 40^\circ\text{C}$

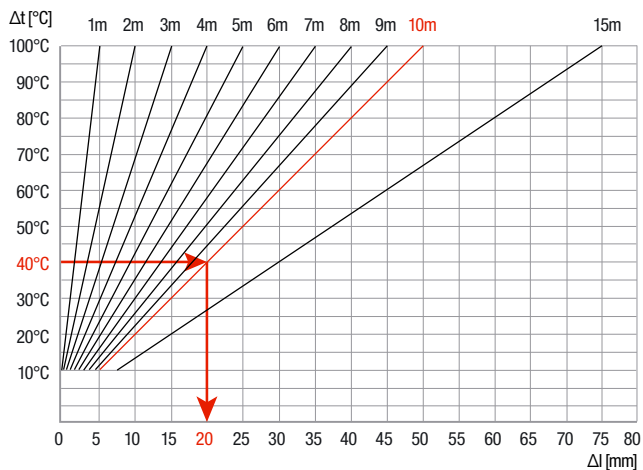

Length of piping [m]	Temperature difference Δt							
	10 °C	20 °C	30 °C	40 °C	50 °C	60 °C	70 °C	80 °C
	Longitudinal difference Δl [mm]							
1	1	1	2	2	3	3	4	4
2	1	2	3	4	5	6	7	8
3	2	3	5	6	8	9	11	12

4	2	4	6	8	10	12	14	16
5	3	5	8	10	13	15	18	20
6	3	6	9	12	15	18	21	24
7	4	7	11	14	18	21	25	28
8	4	8	12	16	20	24	28	32
9	5	9	14	18	23	27	32	36
10	5	10	15	20	25	30	35	40
15	8	15	23	30	38	45	53	60

2.3. Distances of the piping supports

Maximum distance of the supports of all-plastic pipings FV PP-RCT UNI horizontal piping.

Piping diameter [mm]	Distance of supports [cm] at the water temperature		
	20 °C	30 °C	40 °C
16	75	70	70
20	80	75	70
25	85	85	85
32	100	95	95
40	110	110	105
50	125	120	115
63	140	135	130
75	155	150	145
90	165	165	155
110	185	180	175
125	200	195	185

Maximum distance of the piping supports FV PPR CLASSIC S3,2 SDR7,4 (PN16) and FV PP-RCT HOT S3,2 SDR7,4 horizontal piping

Piping diameter [mm]	Distance of supports [cm] at the water temperature					
	20 °C	30 °C	40 °C	50 °C	60 °C	80 °C
16	80	75	75	70	70	60
20	90	80	80	80	70	65
25	95	95	95	90	80	75
32	110	105	105	100	95	80
40	120	120	115	105	100	95
50	135	130	125	120	115	100
63	155	150	145	135	130	115
75	170	165	160	150	145	125
90	180	180	170	165	160	135
110	200	195	190	180	175	155
125	220	215	200	195	190	165

Maximum distance of the piping supports FV PPR CLASSIC S2,5 SDR6 (PN 20) horizontal piping

Piping diameter [mm]	Distance of supports [cm] at the water temperature					
	20 °C	30 °C	40 °C	50 °C	60 °C	80 °C
16	90	85	85	80	80	65
20	95	90	85	85	80	70
25	100	100	100	95	90	85
32	120	115	115	110	100	90
40	130	130	125	120	115	100
50	150	150	140	130	125	110
63	170	160	155	150	145	125
75	185	180	175	160	155	140
90	200	200	185	180	175	150
110	210	215	210	195	190	165
125	235	230	225	210	200	170

Maximum distance of the piping supports FV PP-RCT FASER COOL horizontal piping.

Piping diameter [mm]	Distance of supports [cm] at the water temperature						
	20 °C	30 °C	40 °C	50 °C	60 °C	70 °C	80 °C
40	120	115	110	105	100	95	90
50	140	135	130	125	120	115	110
63	150	145	140	135	130	125	120
75	165	160	155	150	145	140	130
90	175	170	165	160	155	150	135
110	185	180	175	165	160	155	145
125	205	195	190	180	170	160	150
160	205	195	185	180	170	160	150
200	230	220	210	205	195	185	175
250	260	250	240	230	220	210	195

Maximum distance of the piping support FV PP-RCT HOT and FV PP-RCT STABIOXY horizontal piping.

Piping diameter [mm]	Distance of supports [cm] at the water temperature						
	20 °C	30 °C	40 °C	50 °C	60 °C	70 °C	80 °C
20	100	90	85	85	80	70	65
25	105	100	95	90	85	80	75
32	120	115	110	105	100	95	90
40	130	125	120	115	110	105	100
50	150	145	140	135	130	125	120
63	160	155	150	145	140	135	130
75	180	175	170	165	160	155	145
90	190	185	180	175	170	165	150
110	200	195	190	180	175	170	160
125	220	210	205	195	185	175	165
160	220	210	205	195	185	175	165
200	245	235	225	220	210	200	190
250	275	265	255	245	235	225	210

For vertical piping the maximum distance of supports is multiplied by the coefficient 1.3.

2.4 Pipe fixing

It is necessary to respect the material of distribution systems, i.e. primarily longitudinal thermal expansivity, necessity of compensations, given operational conditions (combination of pressure and temperature) and the way of connecting.

Fixing of distributions is carried out so as the fixed points and sliding points are distinguished, for the expected longitudinal change of the piping.

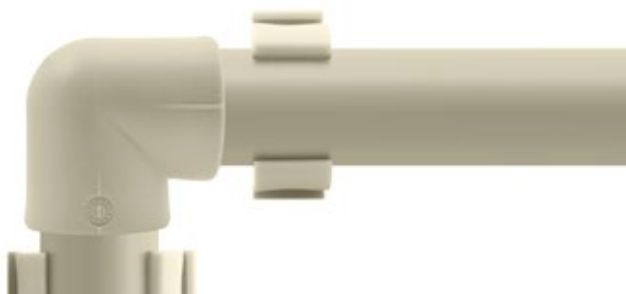

At a pipe bend

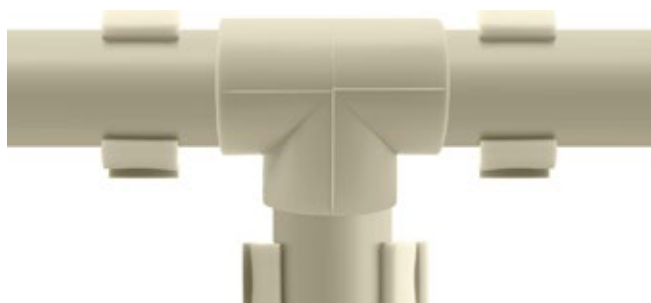

At a branching point



At the point of placing the fitting on the piping

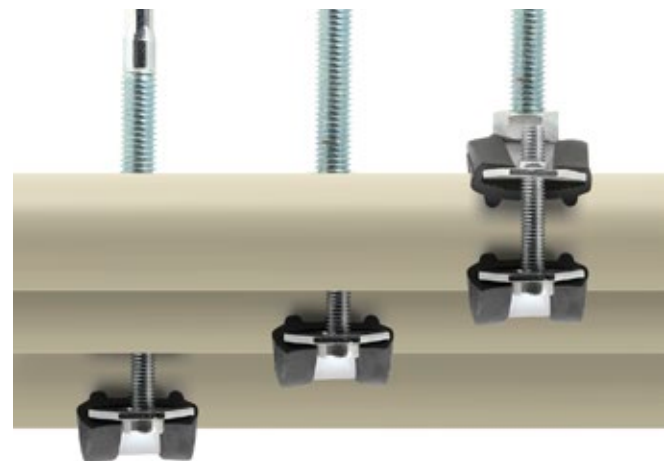

Thanks to the tightly tied sleeves (only horizontal piping)



Fixing at fitting places



Free sleeve

Use of plastic sleeves



Suitable for cold water distribution systems



In the case of hot water, sleeve is installed with insulation that is larger by one dimension.

Another way of laying of plastic piping

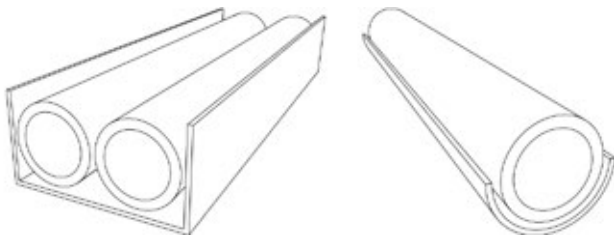

Laying of a pipe into a free gutter.

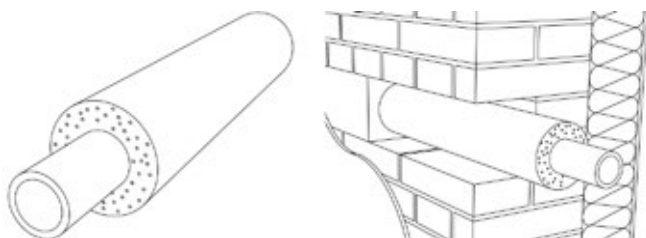

Leading of piping in insulation in wall

Leading of piping

Piping has to be assembled with a decline of at least 0.5 % towards the lowest places, where it is possible to drain it through an independent draining or through closing valves with draining.

Piping must be divided into parts which can be closed independently. For closing, direct valves or cocks are used, for the installation under plastering under-plastering valves or cocks are used. Before the assembly of the elements, it is necessary to test their closability.

For termination of the piping at a place of mixing outlet fixture, it is recommended to use UNIVERSAL WALL MOUNTING GROUP, where the pitch of threads is slid under in such a way that after a potential deflection from the horizontal

axis the distribution could be balanced by levels (etážek). For assemblies under gypsum, a ELBOW FOR GYPSUM WALL MOUNTING should be used.

When leading a water pipe through installation partitions, it is necessary to fix the position of the pipe by suitable fixing, for example by a system of metal sleeves with supporting elements. Piping has to be led with a potential dilatation and insulated.

When leading a water pipe in floor or ceiling constructions, bendable plastic cable ducts (from polyethylene) are used, which ensure mechanical protection of the pipe and at the same time the air gap between the pipe and the cable duct creates thermal insulation. Free plastic water piping has to be furnished with quality insulation (if for example a cold water pipe is led freely at a wall in a heated room, there is a great danger of condensation of humidity at the walls of the pipe). Piping can be led freely at a wall only in premises without the danger of mechanical damage because of operation.

2.5 Leading of an ascending pipe

In the case of an ascending pipe, close attention has to be paid to the layout of fixed points, sliding points and to creating a suitable way of compensation. For ascending pipes, compensation is ensured either by a sliding point at the foot of a standpipe or by using a compensation pipe.

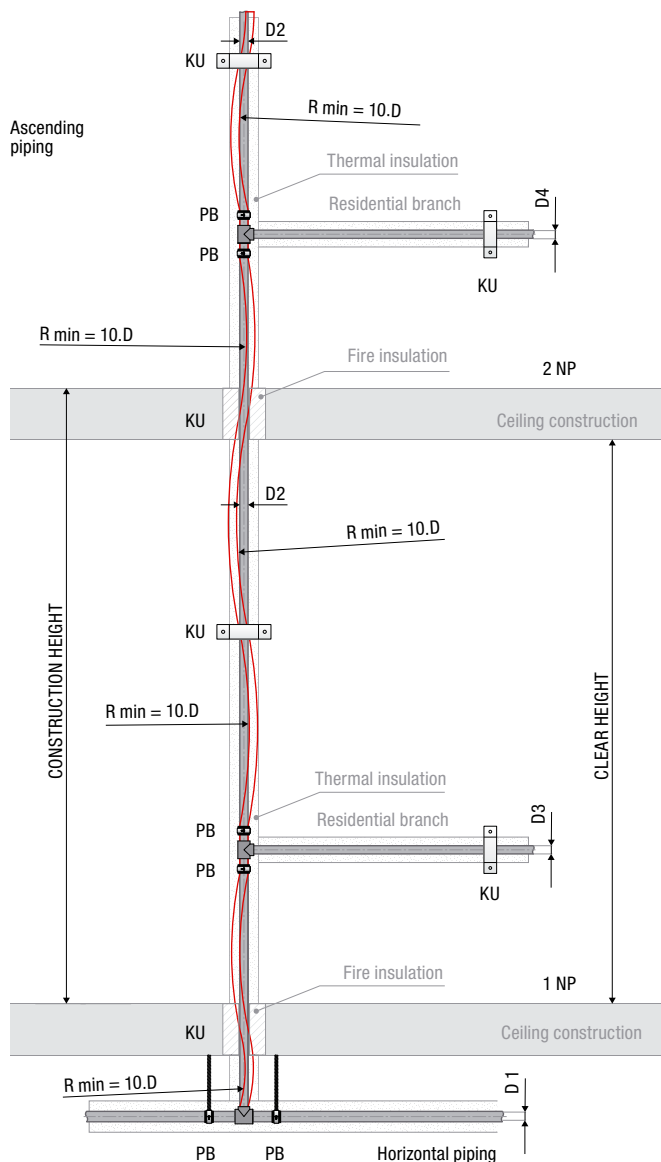

EXPLANATORY NOTES:

	Piping before heating	PB	Fixed point
	Piping after heating	KU	Sliding point
		D	Outer diameter of the piping
		R min	Minimum bend radius

Assembly regulation

If a standpipe needs to be divided into several dilatation sections, this placing of fixed points is carried out. Fixed point at the ascending pipe is installed below and above a T-piece at the branch or at a coupling sleeve at a place of pipe connection, which simultaneously prevents the standpipe from falling. Dilatation between the fixed points then needs to be enabled.

At a place of branching of a connecting pipe, a standpipe dilatation needs to be taken into account:

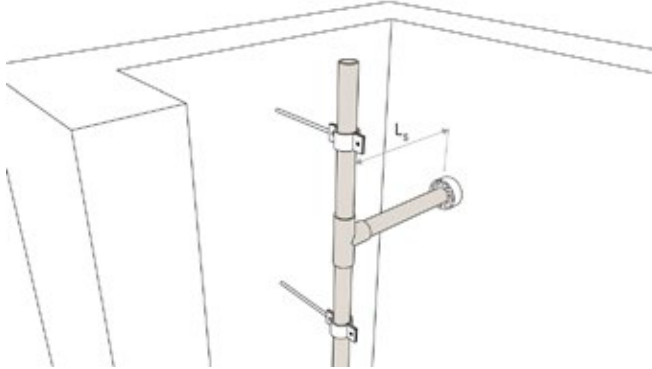

Sufficient distance of a standpipe from a wall penetration

Pipes STABI and FASER have 3x smaller expansivity and 3x higher toughness than all-plastic pipes. Therefore, the pipes can be assembled according to the same principles that were described above in the case of all-plastic pipes, that is to say in a classical procedure of a compensation solution, where a possible larger distance of supports and dilatation and compensational length will be significantly lower. When the piping is led in a groove, so called solid assembly can also be utilized – fixed points are attached to the pipe in such a way that the thermal expansivity is transferred to the pipe material and it does not manifest. This assembly assumes sleeves which will be able to truly hold the pipe and which will be anchored firmly enough.

2.6 Connecting into a system

A piping system can be connected by welding or by mechanical links.

Connecting a pipe with a pipe fitting is carried out in the same way for all types of pipes, pipe fittings are identical. Before welding, in the case of the STABI and STABIOXY pipes, it is necessary to remove the outer PPR and the middle aluminium layer using pipe shavers to the length of the insertion.



Pipes and pipe fittings are being connected by polyfusion welding, larger diameters by means of electro pipe fitting or by butt welding. All the methods have to be carried out exactly in accordance with approved working procedures.

Dividing of pipes

Pipes can be divided (cut) only by sharply ground tools. It is recommended to use special shears or a cutter for plastic pipes.



For plastic – metal transitions in hot water and heating piping systems, plumber's unions with impressed brass nickel-plated male and female threads are strictly used.

For tightening of threaded links with impressed threads, tightening spanners with tape are used, if the plumber's union is not furnished with a polyhedron directly at its metal part.

WARNING: Using of plumber's unions with plastic threads is unacceptable for sanitary technology, because of thermal-technical and physical-mechanical reasons. Plumber's unions with plastic threads can be used for example in the case of establishing temporary distribution systems.

Link sealing

Sealing of threaded links is carried out exclusively by Teflon tape, Teflon thread or by a special sealant.



FV
PLAST®

FV MULTIPIPES

FV MULTIPERT-AL pipe in coil

System: **FV AQUA**
 Material: PE-RT/AL/PE-RT
 Standard: ČSN EN ISO 21003, DIN 4726

Details: 5-layer polyethylene pipe PE-RT II with one layer made from aluminium, increased heat resistance (according to EN ISO 22391), with oxygen barrier from aluminium according to DIN 4726, T_{max} 95 °C.

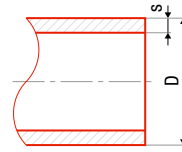

						#	D [mm]	s [mm]	l [m]
16 × 2,0	m	200		0,105	0,200	AA130016200	16	2,0	200
18 × 2,0	m	200		0,123	0,250	AA130018200	18	2,0	200
20 × 2,0	m	100		0,148	0,310	AA130020100	20	2,0	100
20 × 2,0	m	200		0,148	0,310	AA130020200	20	2,0	200
25 × 2,5	m	50		0,228	0,490	AA130025050	25	2,5	50
26 × 3,0	m	50		0,262	0,534	AA130026050	26	3,0	50
32 × 3,0	m	50		0,344	0,800	AA130032050	32	3,0	50

FV MULTIPERT-AL pipe in stick

System: **FV AQUA**
 Material: PE-RT/AL/PE-RT
 Standard: ČSN EN ISO 21003, DIN 4726

Details: 5-layer polyethylene pipe PE-RT II with one layer made from aluminium, increased heat resistance (according to EN ISO 22391), with oxygen barrier from aluminium according to DIN 4726, T_{max} 95 °C.

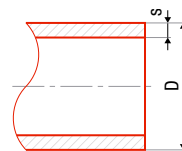

						#	D [mm]	s [mm]	l [m]
16 × 2,0	m	160		0,105	0,200	AA130016004	16	2,00	4
18 × 2,0	m	120		0,123	0,250	AA130018004	18	2,00	4
20 × 2,0	m	100		0,148	0,310	AA130020004	20	2,00	4
25 × 2,5	m	60		0,228	0,490	AA130025004	25	2,50	4
26 × 3,0	m	60		0,262	0,534	AA130026004	26	3,00	4
32 × 3,0	m	40		0,344	0,800	AA130032004	32	3,00	4
40 × 3,5	m	24		0,538	1,260	AA130040004	40	3,50	4
50 × 4,0	m	16		0,811	1,960	AA130050004	50	4,00	4
63 × 4,5	m	12		1,220	3,12	AA130063004	63	4,50	4

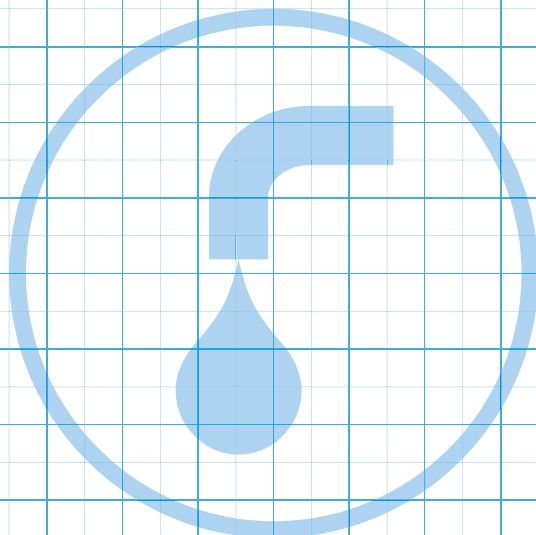

FV M-PRESS BRASS PRESS FITTINGS

FV M-PRESS reducer with cap nut

System: **FV AQUA**
 Material: MET
 Standard: EN ISO 21003
 Details: Transition fitting from FV MULTI part to metal part of pipeline.

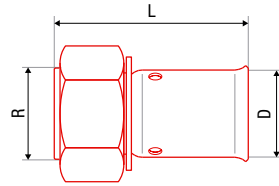

Size	Unit	Grid 1	Grid 2	Grid 3	Grid 4	#	D [mm]	L [mm]	R
16 x 2,0 - 3/8"	pcs			10		AA300016038	16	54	3/8"
16 x 2,0 - 1/2"	pcs			10		AA300016012	16	56	1/2"
16 x 2,0 - 3/4"	pcs			10		AA300016034	16	56	3/4"
20 x 2,0 - 1/2"	pcs			10		AA300020012	20	57	1/2"
20 x 2,0 - 3/4"	pcs			10		AA300020034	20	56	3/4"
26 x 3,0 - 3/4"	pcs			5		AA300026034	26	60	3/4"
26 x 3,0 - 1"	pcs			5		AA300026001	26	58	1"
32 x 3,0 - 1"	pcs			2		AA300032001	32	63	1"
32 x 3,0 - 1 1/4"	pcs			2		AA300032054	32	57	1 1/4"

FV M-PRESS reducing sleeve with metal female thread

System: **FV AQUA**
 Material: MET
 Standard: EN ISO 21003
 Details: Transition fitting from FV MULTI part to metal part of pipeline.

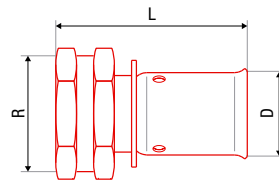

Size	Unit	Grid 1	Grid 2	Grid 3	Grid 4	#	D [mm]	L [mm]	R
16 x 2,0 - 1/2"	pcs			10		AA301016012	16	54	1/2"
16 x 2,0 - 3/4"	pcs			10		AA301016034	16	56	3/4"
18 x 2,0 - 1/2"	pcs			10		AA301018012	18	54	1/2"
18 x 2,0 - 3/4"	pcs			10		AA301018034	18	56	3/4"
20 x 2,0 - 1/2"	pcs			10		AA301020012	20	54	1/2"
20 x 2,0 - 3/4"	pcs			10		AA301020034	20	56	3/4"
20 x 2,0 - 1"	pcs			5		AA301020001	20	63	1"
26 x 3,0 - 3/4"	pcs			5		AA301026034	26	53	3/4"
26 x 3,0 - 1"	pcs			5		AA301026001	26	63	1"
32 x 3,0 - 1"	pcs			5		AA301032001	32	55	1"
32 x 3,0 - 1 1/4"	pcs			5		AA301032054	32	64	1 1/4"
40 x 3,5 - 1 1/4"	pcs			2		AA301040054	40	62	1 1/4"
50 x 4,0 - 1 1/2"	pcs			2		AA301050064	50	71	1 1/2"
63 x 4,5 - 2"	pcs			2		AA301063002	63	78	2"

FV M-PRESS reducing sleeve with metal male thread

System: **FV AQUA**

Material: MET

Standard: EN ISO 21003

Details: Transition fitting from FV MULTI part to metal part of pipeline.

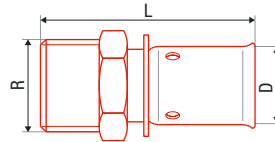

Code	Unit	Grid 1	Grid 2	Grid 3	Grid 4	#	D [mm]	L [mm]	R
16 x 2,0 - 3/8"	pcs			10		AA302016038	16	52	3/8"
16 x 2,0 - 1/2"	pcs			10		AA302016012	16	57	1/2"
16 x 2,0 - 3/4"	pcs			10		AA302016034	16	55	3/4"
18 x 2,0 - 1/2"	pcs			10		AA302018012	18	57	1/2"
18 x 2,0 - 3/4"	pcs			10		AA302018034	18	55	3/4"
20 x 2,0 - 1/2"	pcs			10		AA302020012	20	57	1/2"
20 x 2,0 - 3/4"	pcs			10		AA302020034	20	57	3/4"
26 x 3,0 - 1/2"	pcs			10		AA302026012	26	59	1/2"
26 x 3,0 - 3/4"	pcs			5		AA302026034	26	59	3/4"
26 x 3,0 - 1"	pcs			5		AA302026001	26	62	1"
32 x 3,0 - 1"	pcs			5		AA302032001	32	64	1"
■ 40 x 3,5 - 1 1/4"	pcs			2		AA302040054	40	73	1 1/4"
■ 50 x 4,0 - 1 1/2"	pcs			2		AA302050064	50	79	1 1/2"
■ 63 x 4,5 - 2"	pcs			2		AA302063002	63	89	2"

FV M-PRESS join

System: **FV AQUA**

Material: MET

Standard: EN ISO 21003

Details: A simple, reliable fitting for pipe connection.

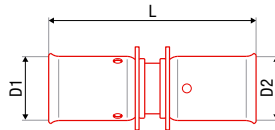

Code	Unit	Grid 1	Grid 2	Grid 3	Grid 4	#	D1 [mm]	L [mm]	D2 [mm]
16 x 2,0 x 16 x 2,0	pcs			10		AA305016000	16	66	16
18 x 2,0 x 18 x 2,0	pcs			10		AA305018000	18	66	18
20 x 2,0 x 20 x 2,0	pcs			10		AA305020000	20	66	20
26 x 3,0 x 26 x 3,0	pcs			10		AA305026000	26	66	26
32 x 3,0 x 32 x 3,0	pcs			5		AA305032000	32	68	32
■ 40 x 3,5 x 40 x 3,5	pcs			2		AA305040000	40	84	40
■ 50 x 4,0 x 50 x 4,0	pcs			2		AA305050000	50	102	50
■ 63 x 4,5 x 63 x 4,5	pcs			2		AA305063000	63	108	63

Press fittings in all metal design for pipeline diameters 16 - 32 mm. The reliable joint is formed using of pressing tongs (system TH), which compresses the stainless steel ring on body of pipe and brass part of fitting. The joint is un-disassembled.



■ Press fittings with plastic ring for pipeline diameters 40 - 63 mm. The reliable joint is formed using of pressing tongs (system TH), which compresses the stainless steel ring on body of pipe and brass part of fitting. The joint is un-disassembled.



FV M-PRESS reduction

System: **FV AQUA**
 Material: MET
 Standard: EN ISO 21003
 Details: A simple, reliable fitting for dimension change of pipeline.

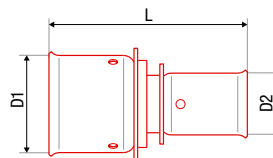

Code	Unit	Grid 1	Grid 2	Grid 3	Grid 4	#	D1 [mm]	L [mm]	D2 [mm]
18 x 2,0 - 16 x 2,0	pcs			10		AA306018016	18	66	16
20 x 2,0 - 16 x 2,0	pcs			10		AA306020016	20	66	16
20 x 2,0 - 18 x 2,0	pcs			10		AA306020018	20	66	18
26 x 3,0 - 16 x 2,0	pcs			10		AA306026016	26	66	16
26 x 3,0 - 18 x 2,0	pcs			10		AA306026018	26	66	18
26 x 3,0 - 20 x 2,0	pcs			10		AA306026020	26	66	20
32 x 3,0 - 16 x 2,0	pcs			5		AA306032016	32	68	16
32 x 3,0 - 20 x 2,0	pcs			5		AA306032020	32	68	20
32 x 3,0 - 26 x 3,0	pcs			5		AA306032026	32	68	26
40 x 3,5 - 20 x 2,0	pcs			2		AA306040020	40	80	20
40 x 3,5 - 26 x 3,0	pcs			2		AA306040026	40	80	26
40 x 3,5 - 32 x 3,0	pcs			2		AA306040032	40	80	32
50 x 4,0 - 20 x 2,0	pcs			2		AA306050020	50	91	20
50 x 4,0 - 26 x 3,0	pcs			2		AA306050026	50	91	26
50 x 4,0 - 32 x 3,0	pcs			2		AA306050032	50	90	32
50 x 4,0 - 40 x 3,5	pcs			2		AA306050040	50	92	40
63 x 4,5 - 40 x 3,5	pcs			2		AA306063040	63	96	40
63 x 4,5 - 50 x 4,0	pcs			2		AA306063050	63	103	50

FV M-PRESS elbow 90°

System: **FV AQUA**
 Material: MET
 Standard: EN ISO 21003
 Details: A simple, reliable fitting for changing the pipeline direction.

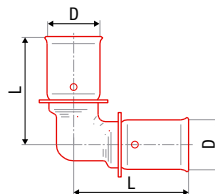

Code	Unit	Grid 1	Grid 2	Grid 3	Grid 4	#	D [mm]	L [mm]	L [mm]
16 x 2,0	pcs			10		AA309016000	16	47	47
18 x 2,0	pcs			10		AA309018000	18	50	50
20 x 2,0	pcs			5		AA309020000	20	50	50
26 x 3,0	pcs			5		AA309026000	26	52	52
32 x 3,0	pcs			5		AA309032000	32	55	55
40 x 3,5	pcs			2		AA309040000	40	66	66
50 x 4,0	pcs			2		AA309050000	50	82	82
63 x 4,5	pcs			2		AA309063000	63	87	87

FV M-PRESS elbow 45°

System: **FV AQUA**
 Material: MET
 Standard: EN ISO 21003
 Details: A simple, reliable fitting for changing the pipeline direction.

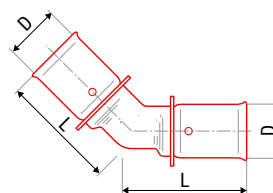

Code	Unit	Grid 1	Grid 2	Grid 3	Grid 4	#	D [mm]	L [mm]	L [mm]
16 x 2,0	pcs			10		AA304516000	16	47	47
18 x 2,0	pcs			10		AA304518000	18	50	50
20 x 2,0	pcs			5		AA304520000	20	50	50
26 x 3,0	pcs			5		AA304526000	26	52	52
32 x 3,0	pcs			5		AA304532000	32	50	50
40 x 3,5	pcs			2		AA304540000	40	58	58
50 x 4,0	pcs			2		AA304550000	50	68	68
63 x 4,5	pcs			2		AA304563000	63	69	69

FV M-PRESS elbow 90° for wall mounting

System: **FV AQUA**
 Material: MET
 Standard: EN ISO 21003
 Details: Fixing fitting with tap connector for mixers.

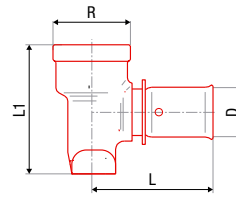

						#	D [mm]	L [mm]	L1 [mm]
16 x 2,0 - 1/2"	pcs		5			AA310016012	16	53	53
18 x 2,0 - 1/2"	pcs		5			AA310018012	18	53	53
20 x 2,0 - 1/2"	pcs		5			AA310020012	20	53	53
20 x 2,0 - 3/4"	pcs		5			AA310020034	20	53	53

FV M-PRESS running elbow 90° for wall mounting

System: **FV AQUA**
 Material: MET
 Standard: EN ISO 21003
 Details: Fixing fitting with tap connector for mixers.

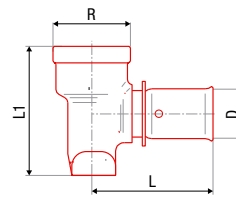

						#	D [mm]	L [mm]	L1 [mm]
16 x 2,0 - 1/2"	pcs		5			AA310116012	16	53	53
18 x 2,0 - 1/2"	pcs		5			AA310118012	18	53	53
20 x 2,0 - 1/2"	pcs		5			AA310120012	20	53	53

FV M-PRESS running elbow 180° for wall mounting

System: **FV AQUA**
 Material: MET
 Standard: EN ISO 21003
 Details: Fixing fitting with tap connector for mixers.

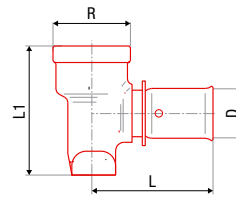

						#	D [mm]	L [mm]	L1 [mm]
16 x 2,0 - 1/2"	pcs		5			AA310216012	16	80	40
18 x 2,0 - 1/2"	pcs		5			AA310218012	18	80	40
20 x 2,0 - 1/2"	pcs		5			AA310220012	20	80	40

FV M-PRESS elbow 90° with metal female thread

System: **FV AQUA**
 Material: MET
 Standard: EN ISO 21003
 Details: Transition fitting from FV MULTI part to metal part of pipeline.

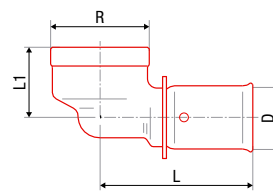

						#	D [mm]	L [mm]	L1 [mm]
16 x 2,0 - 1/2"	pcs		10			AA312016012	16	49	34
18 x 2,0 - 1/2"	pcs		10			AA312018012	18	50	34
20 x 2,0 - 1/2"	pcs		10			AA312020012	20	50	34
20 x 2,0 - 3/4"	pcs		10			AA312020034	20	50	35
26 x 3,0 - 3/4"	pcs		5			AA312026034	26	52	40
26 x 3,0 - 1"	pcs		5			AA312026001	26	55	40
32 x 3,0 - 1"	pcs		5			AA312032001	32	55	46
■ 40 x 3,5 - 1 1/4"	pcs		2			AA312040054	40	66	56
■ 50 x 4,0 - 1 1/2"	pcs		2			AA312050064	50	82	64
■ 63 x 4,5 - 2"	pcs		2			AA312063002	63	87	73

FV M-PRESS elbow 90° with metal male thread

System: **FV AQUA**
 Material: MET
 Standard: EN ISO 21003
 Details: Transition fitting from FV MULTI part to metal part of pipeline.

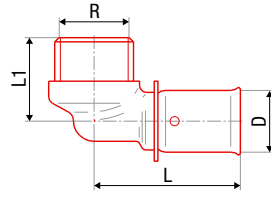

Icon	⊕	⊞	⊞	⊞	⊞	#	D [mm]	L [mm]	L1 [mm]
16 × 2,0 - 3/8"	pcs			10		AA313016038	16	49	30
16 × 2,0 - 1/2"	pcs			10		AA313016012	16	49	35
18 × 2,0 - 1/2"	pcs			10		AA313018012	18	50	35
20 × 2,0 - 1/2"	pcs			10		AA313020012	20	50	35
20 × 2,0 - 3/4"	pcs			10		AA313020034	20	50	35
26 × 3,0 - 3/4"	pcs			5		AA313026034	26	52	43
26 × 3,0 - 1"	pcs			5		AA313026001	26	52	41
32 × 3,0 - 1"	pcs			5		AA313032001	32	55	46
40 × 3,5 - 1 1/4"	pcs			2		AA313040054	40	66	56
50 × 4,0 - 1 1/2"	pcs			2		AA313050064	50	82	64
63 × 4,5 - 2"	pcs			2		AA313063002	63	87	73

FV M-PRESS elbow 90° reducing sleeve with cap nut

System: **FV AQUA**
 Material: MET
 Standard: EN ISO 21003
 Details: Transition fitting from FV MULTI part to metal part of pipeline.

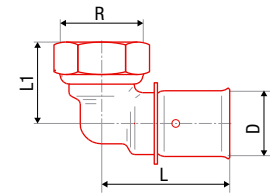

Icon	⊕	⊞	⊞	⊞	⊞	#	D [mm]	L [mm]	L1 [mm]
16 × 2,0 - 1/2"	pcs			10		AA314016012	16	49	35
16 × 2,0 - 3/4"	pcs			10		AA314016034	16	49	35
20 × 2,0 - 1/2"	pcs			10		AA314020012	20	50	35
20 × 2,0 - 3/4"	pcs			10		AA314020034	20	50	35
26 × 3,0 - 3/4"	pcs			5		AA314026034	26	52	38
26 × 3,0 - 1"	pcs			5		AA314026001	26	52	38
32 × 3,0 - 1"	pcs			5		AA314032001	32	55	41
32 × 3,0 - 1 1/4"	pcs			5		AA314032054	32	55	43

FV M-PRESS wall mounting group with tap connectors for gypsum walls

System: **FV AQUA**
 Material: MET
 Standard: EN ISO 21003
 Details: Fixing fitting with tap connector for mixers, for gypsum walls.

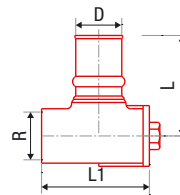

Icon	⊕	⊞	⊞	⊞	⊞	#	D [mm]	L [mm]	L1 [mm]
16 × 2,0 - 1/2"	pcs			1	115	AA315016012	16	48	51,5
20 × 2,0 - 1/2"	pcs			1	123	AA315020012	20	48	51,5

FV M-PRESS wall mounting group with tap connectors

System: **FV AQUA**
 Material: MET
 Standard: EN ISO 21003
 Details: Tap water connectors with adjustable distance.

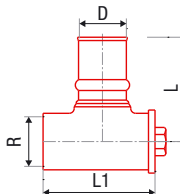

Icon	⊕	⊞	⊞	⊞	⊞	#	D [mm]	L [mm]	L1 [mm]
16 × 2,0 - 1/2"	pcs			1	115	AA316016012	16	48	51,5
20 × 2,0 - 1/2"	pcs			1	123	AA316020012	20	48	51,5

FV M-PRESS tee

System: **FV AQUA**
 Material: MET
 Standard: EN ISO 21003
 Details: A simple, reliable fitting for branching the pipeline.

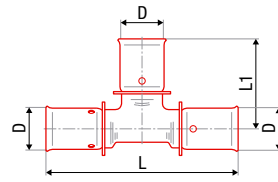

Objekt	Symbol	Okna	Stĺpce	Uzavretie	Objekt	#	D [mm]	L [mm]	L1 [mm]
16 x 2,0	pcs		10			AA317016000	16	93	47
18 x 2,0	pcs		10			AA317018000	18	100	50
20 x 2,0	pcs		5			AA317020000	20	100	50
26 x 3,0	pcs		2			AA317026000	26	104	52
32 x 3,0	pcs		5			AA317032000	32	110	55
■ 40 x 3,5	pcs		2			AA317040000	40	132	66
■ 50 x 4,0	pcs		2			AA317050000	50	164	82
■ 63 x 4,5	pcs		2			AA317063000	63	174	87

FV M-PRESS tee reduced

System: **FV AQUA**
 Material: MET
 Standard: EN ISO 21003
 Details: A simple, reliable fitting for branching the pipeline.

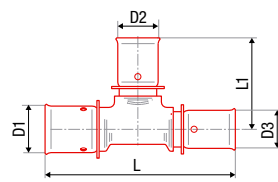

Objekt	Symbol	Okna	Stĺpce	Uzavretie	Objekt	#	D1 [mm]	D2 [mm]	D3 [mm]	L [mm]	L1 [mm]
16 - 20 - 16	pcs		5			AA318162016	16	20	16	100	50
18 - 16 - 16	pcs		10			AA318181616	18	16	16	100	50
18 - 16 - 18	pcs		10			AA318181618	18	16	18	100	50
18 - 18 - 16	pcs		10			AA318181816	18	18	16	100	50
20 - 16 - 16	pcs		10			AA318201616	20	16	16	100	50
20 - 16 - 20	pcs		5			AA318201620	20	16	20	100	50
20 - 18 - 18	pcs		5			AA318201818	20	18	19	100	50
20 - 18 - 20	pcs		5			AA318201820	20	18	20	100	50
20 - 20 - 16	pcs		5			AA318202016	20	20	16	100	50
20 - 26 - 20	pcs		5			AA318202620	20	26	20	106	53
26 - 16 - 16	pcs		5			AA318261616	26	16	16	105	53
26 - 16 - 20	pcs		5			AA318261620	26	16	20	105	53
26 - 16 - 26	pcs		5			AA318261626	26	16	26	104	53
26 - 18 - 26	pcs		5			AA318261826	26	18	26	104	52
26 - 20 - 16	pcs		5			AA318262016	26	20	16	105	53
26 - 20 - 20	pcs		5			AA318262020	26	20	20	104	52
26 - 20 - 26	pcs		5			AA318262026	26	20	26	104	52
26 - 26 - 16	pcs		5			AA318262616	26	26	16	104	52
26 - 26 - 20	pcs		5			AA318262620	26	26	20	104	52
26 - 32 - 26	pcs		2			AA318263226	26	32	26	112	55
32 - 20 - 20	pcs		2			AA318322020	32	20	20	110	55
32 - 20 - 26	pcs		5			AA318322026	32	20	26	110	55
32 - 16 - 32	pcs		2			AA318321632	32	16	32	110	55
32 - 18 - 32	pcs		2			AA318321832	32	18	32	110	55
32 - 20 - 32	pcs		2			AA318322032	32	20	32	110	55
32 - 26 - 26	pcs		2			AA318322626	32	26	26	110	55
32 - 26 - 32	pcs		2			AA318322632	32	26	32	110	55
■ 40 - 20 - 40	pcs		2			AA318402040	40	20	40	132	62
■ 40 - 26 - 40	pcs		2			AA318402640	40	26	40	132	62
■ 40 - 32 - 40	pcs		2			AA318403240	40	32	50	132	62
■ 50 - 16 - 50	pcs		2			AA318501650	50	16	50	164	69
■ 50 - 20 - 50	pcs		2			AA318502050	50	20	50	164	69
■ 50 - 26 - 50	pcs		2			AA318502650	50	26	50	164	69
■ 50 - 32 - 50	pcs		2			AA318503250	50	32	50	164	69
■ 50 - 40 - 40	pcs		2			AA318504040	50	40	40	155	73
■ 50 - 40 - 50	pcs		2			AA318504050	50	40	50	164	73
■ 63 - 26 - 63	pcs		2			AA318632663	63	26	63	174	74
■ 63 - 32 - 63	pcs		2			AA318633263	63	32	63	174	74
■ 63 - 40 - 63	pcs		2			AA318634063	63	40	63	174	78
■ 63 - 50 - 63	pcs		2			AA318635063	63	50	63	174	87

FV M-PRESS tee with metal female thread

System: **FV AQUA**

Material: MET

Standard: EN ISO 21003

Details: Transition fitting from FV MULTI part to metal part of pipeline.

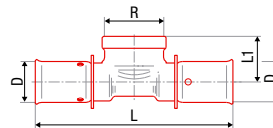

Icon	Symbol	Grid	Grid	Icon	dm³	#	D [mm]	L [mm]	L1 [mm]
	16 × 2,0 - 1/2"	pcs		5		AA319016012	16	97	34
	18 × 2,0 - 1/2"	pcs		5		AA319018012	18	100	34
	18 × 2,0 - 3/4"	pcs		5		AA319018034	18	100	35
	20 × 2,0 - 1/2"	pcs		5		AA319020012	20	100	34
	20 × 2,0 - 3/4"	pcs		5		AA319020034	20	100	35
	26 × 3,0 - 1/2"	pcs		5		AA319026012	26	104	40
	26 × 3,0 - 3/4"	pcs		5		AA319026034	26	104	40
	32 × 3,0 - 1/2"	pcs		2		AA319032012	32	110	45
	32 × 3,0 - 3/4"	pcs		2		AA319032034	32	110	46
	32 × 3,0 - 1"	pcs		2		AA319032001	32	110	46
■	40 × 3,5 - 3/4"	pcs		2		AA319040034	40	132	37
■	40 × 3,5 - 1"	pcs		2		AA319040001	40	132	57
■	40 × 3,5 - 1 1/4"	pcs		2		AA319040054	40	132	57
■	50 × 4,0 - 3/4"	pcs		2		AA319050034	50	164	37
■	50 × 4,0 - 1"	pcs		2		AA319050001	50	164	41
■	50 × 4,0 - 1 1/2"	pcs		2		AA319050064	50	164	64
■	63 × 4,5 - 3/4"	pcs		2		AA319063034	63	174	42
■	63 × 4,5 - 1"	pcs		2		AA319063001	63	174	45
■	63 × 4,5 - 2"	pcs		2		AA319063002	63	174	73

FV M-PRESS tee with metal male thread

System: **FV AQUA**

Material: MET

Standard: EN ISO 21003

Details: Transition fitting from FV MULTI part to metal part of pipeline.

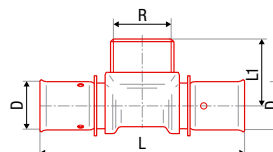

Icon	Symbol	Grid	Grid	Icon	dm³	#	D [mm]	L [mm]	L1 [mm]
	16 × 2,0 - 1/2"	pcs		5		AA320016012	16	97	35
	16 × 2,0 - 3/4"	pcs		5		AA320016034	16	97	35
	18 × 2,0 - 1/2"	pcs		5		AA320018012	18	100	35
	18 × 2,0 - 3/4"	pcs		5		AA320018034	18	100	35
	20 × 2,0 - 1/2"	pcs		5		AA320020012	20	100	35
	20 × 2,0 - 3/4"	pcs		5		AA320020034	20	100	35
	26 × 3,0 - 3/4"	pcs		5		AA320026034	26	104	43
	32 × 3,0 - 1"	pcs		2		AA320032001	32	110	46
■	40 × 3,5 - 1 1/4"	pcs		2		AA320040054	40	132	57
■	50 × 4,0 - 1 1/2"	pcs		2		AA320050064	50	164	65

FV M-PRESS shut off ball valve lux straight with chrome handle

System: **FV AQUA**

Material: MET

Standard: EN ISO 21003

Details: An elegant above-plaster ball valve for closing branches of a distribution system.

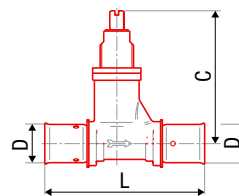

Icon	Symbol	Grid	Grid	Icon	dm³	#	L [mm]	C _{min} -C _{max} [mm]	E _{max} [mm]
	16 × 2,0	pcs		4		AA321016000	148	23 - 38	86
	18 × 2,0	pcs		4		AA321018000	148	23 - 38	86
	20 × 2,0	pcs		4		AA321020000	148	23 - 38	86
	26 × 3,0	pcs		4		AA321026000	154	26 - 41	89

FV M-PRESS shut off ball valve straight with cover

System: **FV AQUA**

Material: MET

Standard: EN ISO 21003

Details: An elegant above-plaster ball valve for closing branches of a distribution system.

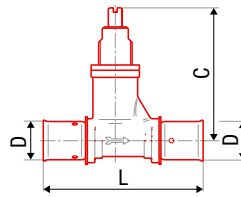

Objekt	Symbol	Objekt	Objekt	Objekt	Objekt	#	L [mm]	C _{min} -C _{max} [mm]	E _{min} -E _{max} [mm]
16 × 2,0	pcs		4			AA323016000	148	36 - 51	83 - 96
18 × 2,0	pcs		4			AA323018000	148	36 - 51	83 - 96
20 × 2,0	pcs		4			AA323020000	148	36 - 51	83 - 96
26 × 3,0	pcs		4			AA323026000	154	39 - 54	86 - 99

FV M-PRESS joining elbow 90° to the radiator

System: **FV AQUA**

Material: MET

Standard: EN ISO 21003

Details: For radiator connection.

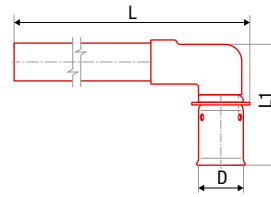

Objekt	Symbol	Objekt	Objekt	Objekt	Objekt	#	D [mm]	L [mm]	
16 × 2,0 - Cu 15	pcs		2			AA324016015	15	300	
20 × 2,0 - Cu 15	pcs		2			AA324020015	15	300	

FV M-PRESS reducing sleeve to CU

System: **FV AQUA**

Material: MET

Standard: EN ISO 21003

Details: Transition fitting from FV MULTI part to cooper part of pipeline.

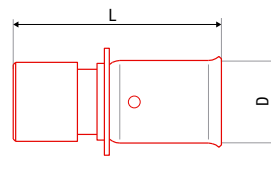

Objekt	Symbol	Objekt	Objekt	Objekt	Objekt	#	D [mm]	L [mm]	
16 × 2,0 - Cu 14	pcs		10			AA326016014	16	62	
16 × 2,0 - Cu 15	pcs		10			AA326016015	16	62	
16 × 2,0 - Cu 16	pcs		10			AA326016016	16	62	
20 × 2,0 - Cu 18	pcs		10			AA326020018	20	63	
20 × 2,0 - Cu 22	pcs		10			AA326020022	25	60	

FV M-PRESS blinding

System: **FV AQUA**

Material: MET

Standard: EN ISO 21003

Details: For permanent or temporary blinding of a branch.

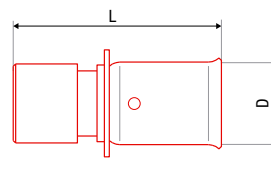

Objekt	Symbol	Objekt	Objekt	Objekt	Objekt	#	D [mm]	L [mm]	
16 × 2,0	pcs		10			AA327016000	16	35	
18 × 2,0	pcs		10			AA327018000	18	35	
20 × 2,0	pcs		10			AA327020000	20	35	
26 × 3,0	pcs		10			AA327026000	26	35	
32 × 3,0	pcs		10			AA327032000	32	36	

FV P-PRESS PLASTIC PRESS FITTINGS

FV P-PRESS reducing sleeve with metal male thread

System: **FV AQUA**
 Material: PPSU/stainless steel, *brass/stainless steel
 Standard: EN ISO 15875, EN ISO 21003
 Details: Transition fitting from FV MULTI part to metal part of pipeline.

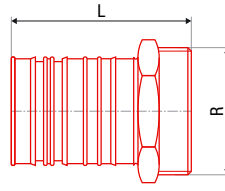

Image	Symbol	Grid	Grid	Grid	#	R	L [mm]	
	pcs			5	AA350016012	1/2"	48	
	pcs			5	AA350020012	1/2"	48	
	pcs			5	AA350020034	3/4"	50	
	pcs			5	AA350025034	3/4"	55	
	pcs			5	AA350025001	1"	42	
	pcs			5	AA350032001	1"	43	
	pcs			1	AA350040054	1 1/4"	55	

FV P-PRESS reducing sleeve with metal female thread

System: **FV AQUA**
 Material: brass/stainless steel
 Standard: EN ISO 15875, EN ISO 21003
 Details: Transition fitting from FV MULTI part to metal part of pipeline.

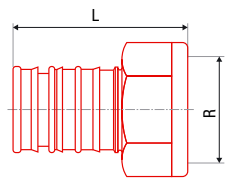

Image	Symbol	Grid	Grid	Grid	#	R	L [mm]	
	pcs			5	AA351016012	1/2"	48	
	pcs			5	AA351020012	1/2"	48	
	pcs			5	AA351020034	3/4"	50	
	pcs			5	AA351025034	3/4"	55	
	pcs			5	AA351032001	1"	43	

FV P-PRESS reducer with cap nut

System: **FV AQUA**
 Material: PPSU/stainless steel, *brass/stainless steel
 Standard: EN ISO 15875, EN ISO 21003
 Details: Transition fitting from FV MULTI part to metal part of pipeline.

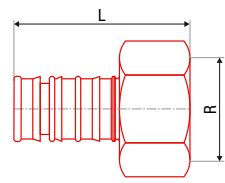
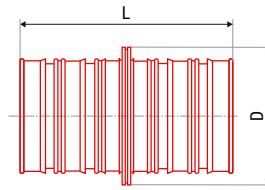

Image	Symbol	Grid	Grid	Grid	#	R	L [mm]	
	pcs			5	AA352016012	1/2"	40	
	pcs			5	AA352020012	1/2"	40	
	pcs			5	AA352020034	3/4"	42	
	pcs			5	AA352025034	3/4"	47	
	pcs			5	AA352025001	1"	39	
	pcs			5	AA352032001	1"	47	
	pcs			1	AA352040054	1 1/4"	47	

FV P-PRESS join

System: **FV AQUA**
 Material: PPSU/stainless steel, *brass/stainless steel
 Standard: EN ISO 15875, EN ISO 21003
 Details: A simple, reliable fitting for pipe connection.



Icon	Symbol	Grid	Grid	Grid	#	D [mm]	L [mm]	
	16 - 16	pcs		5	AA353016016	16	42	
	20 - 20	pcs		5	AA353020020	20	43	
	25 - 25	pcs		5	AA353025025	25	53	
	32 - 32	pcs		5	AA353032032	32	56	
	* 40 - 40	pcs		1	AA353040040	40	77	

FV P-PRESS reduction

System: **FV AQUA**
 Material: PPSU/stainless steel, *brass/stainless steel
 Standard: EN ISO 15875, EN ISO 21003
 Details: A simple, reliable fitting for dimension change of pipeline.

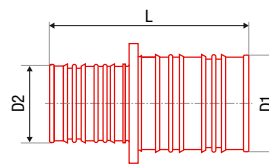

Icon	Symbol	Grid	Grid	Grid	#	D1 [mm]	D2 [mm]	L [mm]
	20 - 16	pcs		5	AA354020016	20	16	43
	25 - 16	pcs		5	AA354025016	25	16	48
	25 - 20	pcs		5	AA354025020	25	20	48
	32 - 25	pcs		5	AA354032025	32	25	54
	* 32 - 40	pcs		1	AA354040032	40	32	66

FV P-PRESS elbow 90°

System: **FV AQUA**
 Material: PPSU/stainless steel, *brass/stainless steel
 Standard: EN ISO 15875, EN ISO 21003
 Details: A simple, reliable fitting for changing the pipeline direction.

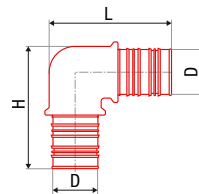

Icon	Symbol	Grid	Grid	Grid	#	D [mm]	L [mm]	H [mm]
	16 x 2,0	pcs		5	AA355016000	16	36	41
	20 x 2,0	pcs		5	AA355020000	20	45	42
	25 x 2,5	pcs		5	AA355025000	25	53	53
	32 x 3,0	pcs		5	AA355032000	32	61	61
	* 40 x 3,5	pcs		1	AA355040000	40	85	85

FV P-PRESS blinding

System: **FV AQUA**
 Material: * PPSU/stainless steel, brass/stainless steel
 Standard: EN ISO 15875, EN ISO 21003
 Details: For permanent or temporary blinding of a branch.

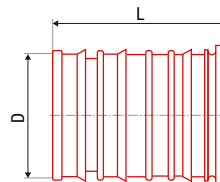

Icon	Symbol	Grid	Grid	Grid	#	D [mm]	L [mm]	
	* 16 x 2,0	pcs		5	AA358016000	16	24	
	20 x 2,0	pcs		5	AA358020000	20	23	
	25 x 2,5	pcs		5	AA358025000	25	28	

FV P-PRESS tee

System: **FV AQUA**
 Material: PPSU, *brass/stainless steel
 Standard: EN ISO 15875, EN ISO 21003
 Details: A simple, reliable fitting for branching the pipeline.

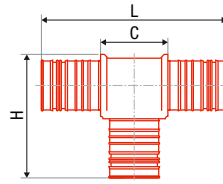

Code	Unit	Material	Standard	Weight	#	C [mm]	L [mm]	H [mm]
16 - 16 - 16	pcs			5	AA356016000	29	66	39
20 - 20 - 20	pcs			5	AA356020000	33	73	45
25 - 25 - 25	pcs			5	AA356025000	30	80	55
32 - 32 - 32	pcs			5	AA356032000	44	97	66
* 40 - 40 - 40	pcs			1	AA356040000	61	67	87

FV P-PRESS tee reduced

System: **FV AQUA**
 Material: PPSU/brass, *brass/stainless steel
 Standard: EN ISO 15875, EN ISO 21003
 Details: A simple, reliable fitting for branching the pipeline.

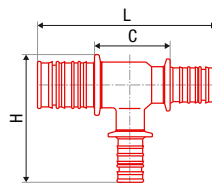

Code	Unit	Material	Standard	Weight	#	C [mm]	L [mm]	H [mm]
20 - 16 - 18	pcs			5	AA357201618	31	69	41
16 - 20 - 20	pcs			5	AA357202016	29	65	42
20 - 16 - 20	pcs			5	AA357201600	33	73	41
20 - 25 - 20	pcs			5	AA357202500	32	72	53
25 - 16 - 25	pcs			5	AA357251600	30	80	48
25 - 16 - 16	pcs			5	AA357251616	34	78	57
25 - 16 - 20	pcs			5	AA357251620	34	79	56
25 - 20 - 16	pcs			5	AA357251620	34	78	57
25 - 20 - 20	pcs			5	AA357252020	31	76	47
25 - 20 - 25	pcs			5	AA357252000	30	80	48
25 - 32 - 25	pcs			5	AA357253200	44	97	66
32 - 25 - 25	pcs			5	AA357322525	45	97	66
32 - 25 - 32	pcs			5	AA357322500	44	97	66
* 40 - 32 - 32	pcs			5	AA357403232	61	56	76

FV P-PRESS manifold 4 circuits

System: **FV AQUA**
 Material: PPSU/stainless steel
 Standard: EN ISO 15875, EN ISO 21003
 Details: A simple, reliable fitting for branching pipeline into 3 branches.

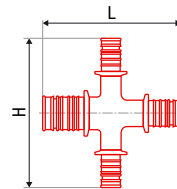

Code	Unit	Material	Standard	Weight	#	L [mm]	H [mm]
25 - 16 - 16 - 20	pcs			1	AA359251620	81	89

FV P-PRESS manifold 5 circuits

System: **FV AQUA**

Material: PPSU/stainless steel

Standard: EN ISO 15875, EN ISO 21003

Details: A simple, reliable fitting for branching pipeline into 4 branches.

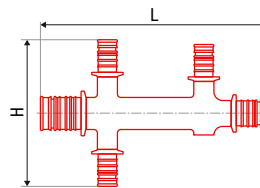

Code	Unit	Qty	Material	#	L [mm]	H [mm]
25 - 16 - 16 - 16 - 16 - 20	pcs	1	AA360251620	139	89	
32 - 16 - 16 - 16 - 16 - 20	pcs	1	AA360321620	138	95	

FV P-PRESS manifold 6 circuits

System: **FV AQUA**

Material: PPSU/stainless steel

Standard: EN ISO 15875, EN ISO 21003

Details: A simple, reliable fitting for branching pipeline into 5 branches.

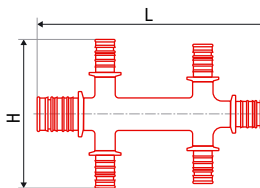

Code	Unit	Qty	Material	#	L [mm]	H [mm]
25 - 16 - 16 - 16 - 16 - 16 - 20	pcs	1	AA361251620	139	89	
32 - 16 - 16 - 16 - 16 - 16 - 20	pcs	1	AA361321620	138	95	

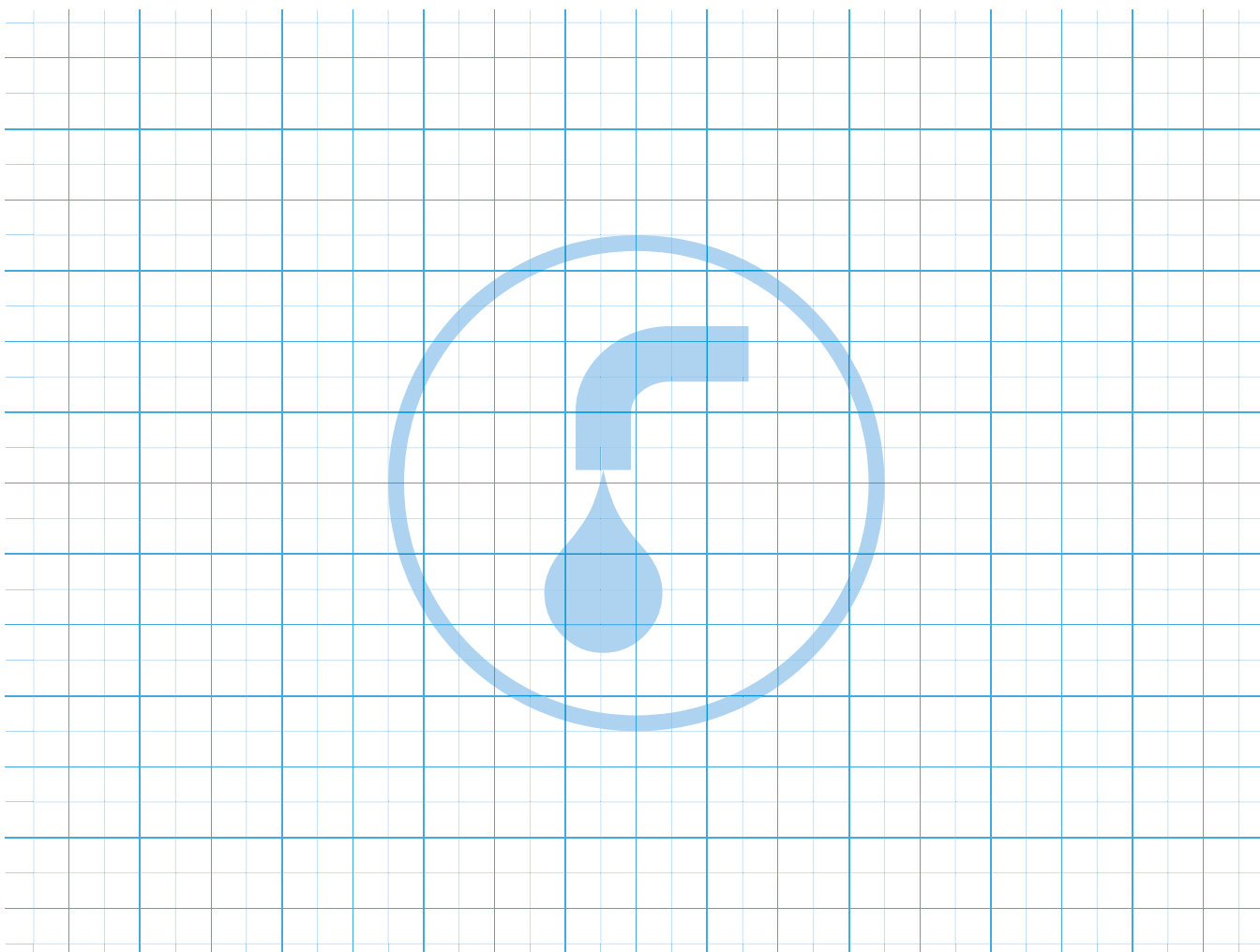

TOOLS AND ACCESSORIES FOR FV MULTIPIPES

Calibrator for FV MULTIPIPES metal

System: **FV AQUA**
 Material: -
 Standard: -
 Details: Robust metal calibrator for the most common diameters of multilayer pipes 16, 20, 25, 32.



Icon	Icon	Icon	Icon	Icon	Icon	#			
Ø 16 - 20 - 25 - 32	pcs	1	1		dm ³	AA429000000			

Calibrator for FV MULTIPIPES metal

System: **FV AQUA**
 Material: -
 Standard: -
 Details: Robust metal calibrator for the most common diameters of multilayer pipes 16, 20, 26, 32.



Icon	Icon	Icon	Icon	Icon	Icon	#			
Ø 16 - 20 - 25 - 32	pcs	1	1		dm ³	AA429000001			

Calibrator for FV MULTIPIPES plastic

System: **FV AQUA**
 Material: -
 Standard: -
 Details: Calibrator of multilayer pipes FV MULTIPIPES for press fittings FV M-PRESS and FV P-PRESS.



Icon	Icon	Icon	Icon	Icon	Icon	#			
Ø 14-32	pcs	5	1		dm ³	AA429000002			

Calibrator for FV MULTIPIPES plastic with shaver

System: **FV AQUA**
 Material: -
 Standard: -
 Details: Calibrator of multilayer pipes FV MULTI for press fittings FV M-PRESS and FV P-PRESS. For diameters 14 - 63 mm.



Icon	Icon	Icon	Icon	Icon	Icon	#			
Ø 14-20	pcs	1	1		dm ³	AA429000003			
Ø 20-40	pcs	1	1		dm ³	AA429000004			
Ø 40-63	pcs	1	1		dm ³	AA429000005			

Bending pipe spring outer for FV MULTIPIPES

System: **FV AQUA**
 Material: -
 Standard: -
 Details: Bending spring ensures a perfect fold multilayer pipes without the risk of pipe breakage.



Icon	Icon	Icon	Icon	Icon	Icon	#			
16 × 2,0	pcs	1	1		dm ³	AA430016000			
18 × 2,0	pcs	1	1		dm ³	AA430018000			
20 × 2,0	pcs	1	1		dm ³	AA430020000			
26 × 3,0	pcs	1	1		dm ³	AA430026000			

Bending pipe spring inner for FV MULTIPIPES

System: **FV AQUA**

Material: -

Standard: -

Details: Bending spring ensures a perfect fold multilayer pipes without the risk of pipe breakage.



						#			
16 x 2,0	pcs	1	1			AA430016001			
18 x 2,0	pcs	1	1			AA430018001			
20 x 2,0	pcs	1	1			AA430020001			
26 x 3,0	pcs	1	1			AA430026001			

REMS pressing jaws Basic E 01

System: **FV AQUA**

Material: -

Standard: -

Details: Universal pressing jaws, for clamping TC inserts for pressing plastic fittings FV P-PRESS. Universal pressing jaws are clamping into the most widely used hydraulic tools.



						#			
16x2,0 - 32x3,0	pcs	1	1			AA422000001			

REMS pressing jaws Mini Basic E 01

System: **FV AQUA**

Material: -

Standard: -

Details: Universal pressing jaws, for clamping TC inserts for pressing plastic fittings FV P-PRESS. Universal pressing jaws are clamping into the most widely used hydraulic tools.



						#			
16x2,0 - 32x3,0	pcs	5	1			AA422000002			

TC inserts into universal pressing jaws for fittings FV P-PRESS

System: **FV AQUA**

Material: -

Standard: -

Details: Special TC inserts into universal jaws E01 BASIC and E01 BASIC MINI for pressing plastic fittings FV P-PRESS. They are suitable for the most widely used hydraulic tools REMS, VIRAX, ROTTENBERGER and KLAUKE for forces from 32 to 40 KN.



						#			
16 x 2,0	pcs	1	1			AA422016000			
18 x 2,0	pcs	1	1			AA422018000			
20 x 2,0	pcs	1	1			AA422020000			
26 x 3,0	pcs	1	1			AA422026000			
32 x 3,0	pcs	1	1			AA422032000			

ASSEMBLY INSTRUCTION FOR CONNECTING OF PIPES WITH PIPE FITTINGS FV M-PRESS AND FV P-PRESS

CHARACTERISTICS

Pipe fittings FV M-PRESS and FV P-PRESS are intended for construction of water and heating distribution systems from multi-layer pipes FV MULTIPERT-5, FV MULTIPERT-AL and FV MULTIPLEX-5.

FV M-PRESS:

- Complete line of first-rate brass pressed pipe fittings for a wide range of uses. Even for the most demanding implementations as in the cases of heating water distribution systems.
- Wide range of diameters from d16 to d63 (according to the type of a pipe fitting)
- Plumber's union with outer or inner thread, eurocone, a cap nut and plumber's union to copper distribution systems, connected by pressing or soldering, ensure an easy connection to any other distribution system.
- Floor or ceiling distributors, unique double-circuit distributor with crossing, elbows and T-pieces for connecting radiators for an easy implementation of heating distributions.

FV P-PRESS

- Line of the most important plastic press pipe fittings made of the PPSU material for economical implementation of distribution systems
- Range from d16 to d32

CONNECTING BY PRESS FITTINGS

FV M-PRESS AND FV P-PRESS

Pipe fittings FV M-PRESS are fundamentally based on perfect sealing of impressed link by means of specially shaped grooves, rubber o-rings and adjustable placement of a cup.



Picture 1: Stainless steel cup ① is attached in adjustable placement ②, which is adapted to the shape of the pressing jaw in the process of pressing and its connection with fitting remains impermeable for penetration of humidity (from the plastering or condensate). Two sealing o-rings ③ ensure perfect sealing of the inner space of the fitting against the pressurized water. The inner space of the fitting is thus protected against humidity thereby successfully preventing potential corrosion of the Al layer at the cut of multi-layer pipes.

Perfect impressing of the link ④ is ensured by the Autolock system, which prevents drawing the jaws of pressing extensions away before the pressing is finished.

Fittings of the line FV M-PRESS meet the most rigorous requirements for ensuring tightness and harmlessness according to the demands of SKZ and DVGW certification authorities).

Pressing fittings FV P-PRESS work along a similar principle with simpler construction. They use different (patented) system of grooves in combination with one sealing o-ring.

Picture 1:

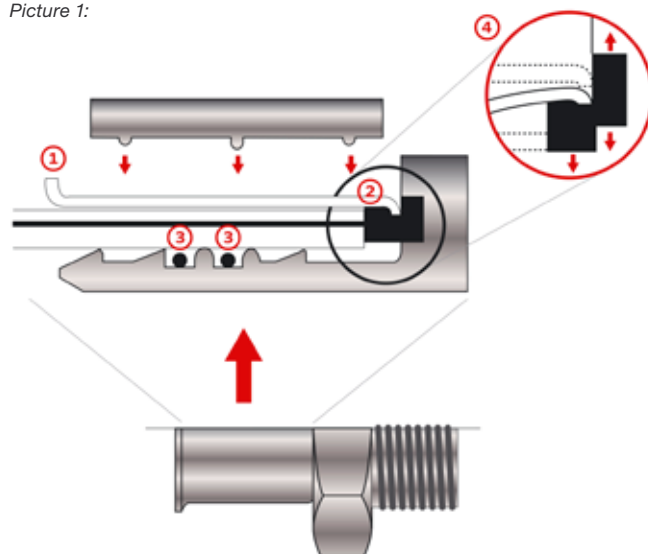

For pressing of FV M-PRESS fittings, standard pressing jaws of the following types are used:

16 × 2,0	=	U, H, TH and RF
18 × 2,0	=	U and H
20 × 2,0	=	U, H, TH and RF
25 × 2,5	=	U, H, TH and RF
32 × 3,0	=	U, H, TH and RF
40 × 3,5	=	U
50 × 4,0	=	U
63 × 4,5	=	U

For pressing of FV P-Press fittings, it is necessary to use TC insertion for universal pressing heads as jaws:

16 × 2,0	=	TC
18 × 2,0	=	TC
20 × 2,0	=	TC
25 × 2,5	=	TC
32 × 3,0	=	TC

TC insertions can be found in the FV AQUA offer – Tools and equipment. Insertions are compatible with usual hydraulic tools of the brands REMS, VIRAX, ROTTENBERGER and KLAUKE for forces from 32 to 40 kN.

PROCEDURE FOR CONNECTING IS IDENTICAL FOR BOTH FV M-PRESS AND FV P-PRESS PIPE FITTINGS:

1. Cut the pipe to a required size with quality shears or a pipe cutter, always PERPENDICULARLY to the pipe.
2. Calibrate the pipe with the pipe calibrator – this way you prevent its damage when sliding onto the fitting.
3. Separate the cup from the pipe fitting and slide the pipe to the sticking point.
4. Slide the pipe with the cup onto the fitting to the sticking point. Correctness of the fitting can be verified by the fact that the pipe must be visible in the checking window on the cup.
5. Insert the pipe fitting in the pressing jaw, so that the cup is centred in the jaws. Never press with jaws covering the edge of the cup!
6. Press the link perfectly.

Simplified procedure in which the cup is left on the piping is not recommended, mainly because of the lack of control over potential deformation or possible o-ring displacement.

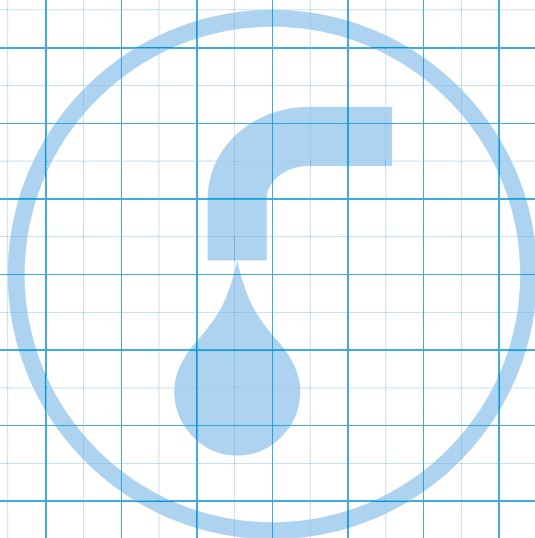

ACCESSORIES

Pipe insulation Tubex (foamed PE)

System: **FV AQUA**
 Material: PE
 Standard: -

Details: Excellent supplement for thermal and acoustic insulation of water distribution and heating. Made of polyethylene foam with soft structure of closed cells. Significantly reduce thermal losses, prevents condensation on distribution of cold water and cooling devices, muffle sound.



mm	⊕	⊞	⊞	⊞	dm ³	#			
18 × 6	m	520	2	0,01	0,92	AA970018006			
18 × 10	m	320	2	0,02	1,50	AA970018010			
22 × 6	m	400	2	0,02	1,20	AA970022006			
22 × 10	m	270	2	0,04	1,78	AA970022010			
28 × 6	m	280	2	0,02	1,71	AA970028006			
28 × 10	m	190	2	0,04	2,53	AA970028010			
35 × 6	m	210	2	0,03	2,29	AA970035006			
35 × 10	m	150	2	0,04	3,20	AA970035010			
42 × 10	m	120	2	0,04	4,00	AA970042010			
42 × 15	m	80	2	0,07	6,00	AA970042015			
52 × 10	m	80	2	0,07	6,00	AA970052010			
52 × 15	m	70	2	0,10	6,86	AA970052015			
65 × 10	m	66	2	0,08	7,27	AA970065010			
65 × 15	m	54	2	0,11	8,89	AA970065015			
76 × 10	m	50	2	0,11	9,60	AA970076010			
76 × 15	m	38	2	0,11	12,63	AA970076015			
92 × 15	m	28	2	0,14	17,14	AA970092015			
92 × 20	m	24	2	0,20	20,00	AA970092020			
114 × 15	m	20	2	0,56	24,00	AA970114015			

Adhesive insulation tape

System: **FV AQUA**
 Material: -
 Standard: -

Details: Double - adhesive tape for attaching insulation on the pipe.



mm	⊕	⊞	⊞	⊞	dm ³	#			
40 mm × 25 m	pcs	1	1	0,214	2,12	AA971000000			

Adhesive tape

System: **FV AQUA**
 Material: -
 Standard: -

Details: Special tape for pasting the cut insulation.

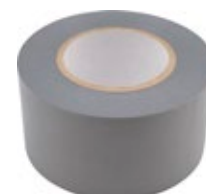

mm	⊕	⊞	⊞	⊞	dm ³	#			
40 mm × 20 m	pcs	1	1	0,142	0,24	AA972000020			

Insulation clip

System: **FV AQUA**
 Material: PPR
 Standard: -
 Details: Special clip for providing insulation of distribution without spaces.



						#			
	pcs	10000	100	0,01	0,01	AA973000000			

Insulation felt

System: **FV AQUA**
 Material: -
 Standard: -
 Details: For thermal insulation of pipes in spaces, where can not be used Tubex insulation.



						#			
70 mm x 10 m	pcs	50	1	0,16	3,10	AA974000000			

O-ring Taboren

System: **FV AQUA**
 Material: PE
 Standard: -
 Details: Special seal for sealing the fittings with cap nut.



						#			
1/2"	pcs	6000	200	0,01	0,01	AA975000012			
3/4"	pcs	3000	300	0,01	0,01	AA975000034			
1"	pcs	2000	300	0,01	0,01	AA975000001			
5/4"	pcs	1400	300	0,01	0,01	AA975000054			
6/4"	pcs	1000	300	0,01	0,01	AA975000064			
2"	pcs	600	300	0,01	0,01	AA975000002			

Teflon insulation tape

System: **FV AQUA**
 Material: -
 Standard: -
 Details: Tape for sealing of fittings with metal thread.



						#			
10 m	pcs	300	10	0,01	0,06	AA975001010			

Plastic clip PP

System: **FV AQUA**

Material: PPR

Standard: -

Details: Plastic clip for sliding point of pipe on the wall.

Note: When ordering the black color of the clip, replace the AA ... for BB ..., or contact the customer service.

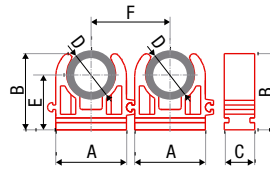

QTY	⊕	⊞	⊠	⊡	⊣	# ●	# ●	A [mm]	B [mm]	C [mm]	E [mm]	F [mm]
16	pcs	750	50	0,02	0,03	AA976016001	WA976016001	33,7	29,9	15,7	24,2	30,0
20	pcs	400	50	0,03	0,05	AA976020001	WA976020001	30,0	32,3	16,0	24,4	34,5
25	pcs	400	50	0,05	0,06	AA976025001	WA976025001	35,3	38,0	16,0	28,0	39,5

Plastic double clip PP

System: **FV AQUA**

Material: PPR

Standard: -

Details: Plastic clip for sliding point of parallel pipe on the wall.

Note: When ordering the black color of the clip, replace the AA ... for BB ..., or contact the customer service.

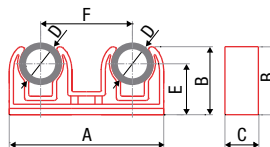

QTY	⊕	⊞	⊠	⊡	⊣	# ●	# ●	A [mm]	B [mm]	C [mm]	E [mm]	F [mm]
2 × 16	pcs	500	50	0,01	0,04	AA976016002	WA976016002	65,3	30,2	15,9	24,2	40,4
2 × 20	pcs	450	50	0,02	0,05	AA976020002	WA976020002	70,5	34,8	15,9	25,5	43,4
2 × 25	pcs	200	50	0,03	0,06	AA976025002	WA976025002	89,0	40,0	15,8	27,8	54,7

Plastic clip with stirrup

System: **FV AQUA**

Material: PPR

Standard: -

Details: Plastic clip with stirrup for sliding point of pipe on the wall and ceiling.

Note: When ordering the black color of the clip, replace the AA ... for BB ..., or contact the customer service.

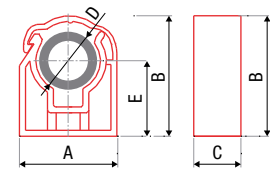

QTY	⊕	⊞	⊠	⊡	⊣	# ●	# ●	A [mm]	B [mm]	C [mm]	E [mm]
15	pcs	600	50	0,01	0,03	AA977015001	WA977015001	25,0	33,5	16,0	22,5
16	pcs	600	50	0,01	0,03	AA977016001	WA977016001	26,0	34,0	16,0	23,0
18	pcs	600	50	0,01	0,03	AA977018001	WA977018001	28,0	36,5	16,0	24,0
20	pcs	400	50	0,02	0,04	AA977020001	WA977020001	31,0	38,0	16,0	25,0
22	pcs	400	50	0,02	0,04	AA977022001	WA977022001	33,0	40,5	16,0	26,0
25	pcs	400	50	0,02	0,04	AA977025001	WA977025001	35,0	43,5	16,0	28,0

Plastic double clip with stirrup

System: **FV AQUA**

Material: PPR

Standard: -

Details: Plastic clip with stirrup for sliding point of parallel pipe on the wall and ceiling.

Note: When ordering the black color of the clip, replace the AA ... for BB ..., or contact the customer service.

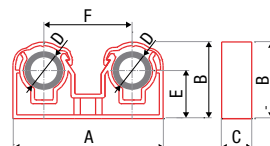

QTY	⊕	⊞	⊠	⊡	⊣	# ●	# ●	A [mm]	B [mm]	C [mm]	E [mm]	F [mm]
15	pcs	200	50	0,02	0,06	AA977015002	WA977015002	61,2	33,5	16,0	22,5	36,2
18	pcs	300	50	0,02	0,06	AA977018002	WA977018002	70,2	36,5	16,0	24,0	42,2
20	pcs	300	50	0,04	0,08	AA977020002	WA977020002	76,2	38,0	16,0	25,0	45,2
22	pcs	300	50	0,04	0,08	AA977022002	WA977022002	81,2	40,5	16,0	26,0	48,2
25	pcs	150	50	0,04	0,08	AA977025002	WA977025002	90,2	43,5	16,0	28,0	55,2

Spacing clip for cold water

System: **FV AQUA**

Material: PPR

Standard: -

Details: Universal plastic clip for sliding point of pipes of different diameters on the wall and ceiling.

Note: When ordering the black color of the clip, replace the AA ... for BB ..., or contact the customer service.

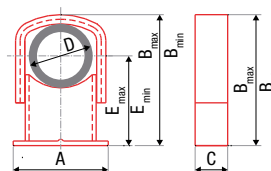

						#	#	A [mm]	B _{min} [mm]	B _{max} [mm]	C [mm]	E _{max} [mm]	E [mm]
16-25	pcs	200	50	0,01	0,05	AA978016025	WA978016025	43,2	42,0	51,5	29,5 (32)	30,0	34,5
25-50	pcs	50	25	0,05	0,20	AA978025050	WA978025050	70,2	76,5	101,5	35,4 (38)	56,5	69,0

Plastic clip with strap

System: **FV AQUA**

Material: -

Standard: -

Details: Reliable clip with strap for sliding point of pipe on the wall and ceiling.

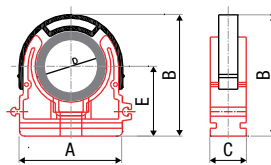

						#	A [mm]	B [mm]	C [mm]	E [mm]
32	pcs	400	50	0,02	0,05	AA979032000	52,5	54,7	15,8	31,8
40	pcs	300	50	0,03	0,06	AA979040000	63,4	63,6	15,8	36,6
50	pcs	150	25	0,04	0,16	AA979050000	80,2	77,0	18,7	40,4
63	pcs	100	25	0,05	0,19	AA979063000	96,3	91,0	18,9	46,6
75	pcs	60	1	0,10	0,38	AA979075000	120,1	90,6	24,1	62,5
90	pcs	40	1	0,12	0,50	AA979090000	138,7	129,3	24,2	68,3
110	pcs	30	1	0,15	0,64	AA979110000	164,0	149,2	24,0	78,3

Metal sleeve

System: **FV AQUA**

Material: -

Standard: -

Details: For fixing point, also suitable for vertical pipeline. Creates a fixing point - must be taken into account when planning compensation.



						#				
20	pcs	100	1	0,04	0,04	AA980020000				
25	pcs	100	1	0,04	0,04	AA980025000				
32	pcs	100	1	0,05	0,05	AA980032000				
40	pcs	100	1	0,06	0,06	AA980040000				
50	pcs	50	1	0,07	0,16	AA980050000				
63	pcs	50	1	0,11	0,19	AA980063000				
75	pcs	50	1	0,16	0,38	AA980075000				
90	pcs	50	1	0,19	0,50	AA980090000				
110	pcs	50	1	0,25	0,64	AA980110000				

Screw combi

System: **FV AQUA**

Material: -

Standard: -

Details: Screw for metal sleeve.



						#				
M8 x 100	pcs	100	1	0,04	0,04	AA981008100				

Dowels

System: **FV AQUA**

Material: PPR

Standard: -

Details: High quality dowels with square cross section and thick wall.

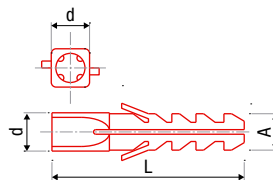

Size	Unit	Quantity	Weight [kg]	Volume [dm³]	#	A [mm]	d [mm]	L [mm]
6 mm	pcs	800	0,01	0,03	AA982006000	5,6	6	30
8 mm	pcs	480	0,02	0,04	AA982008000	7,5	8	40
10 mm	pcs	170	0,03	0,07	AA982010000	9,5	10	50
12 mm	pcs	120	0,04	0,13	AA982012000	11,7	12	60

Threaded bar

System: **FV AQUA**

Material: Galvanized steel

Standard: -

Details: Threaded bar made from quality galvanized steel.



Size	Unit	Quantity	Weight [kg]	Volume [dm³]	#
M8 x 1000 mm	pcs	50	0,04	0,33	AA983008000

Clamping strap

System: **FV AQUA**

Material: -

Standard: -

Poznámka: Universal strap for binding pipes together.



Size	Unit	Quantity	Weight [kg]	Volume [dm³]	#
7,6 x 400	pcs	100	0,01	0,01	AA984000000

Plastic trough

System: **FV AQUA**

Material: PVC - RE

Standard: -

Details: Perspective plastic trough from PVC suitable for lead the pipes. Standard length 4m.

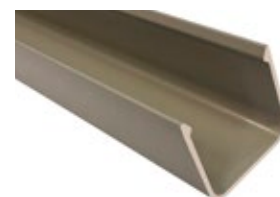

Size	Unit	Quantity	Weight [kg/bm]	Volume [dm³/bm]	#
120 x 100 x 4000 mm	m	1	1,75	12	AA985012004

Trough cover plastic

System: **FV AQUA**

Material: PVC - RE

Standard: -

Details: Cover for trough with reliable set system. Standard length 1m. Color grey.



Size	Unit	Quantity	Weight [kg/bm]	Volume [dm³/bm]	#
146 x 30 x 1000 mm	m	1	1,3	4,38	AA986013001

Galvanized trough (2 m length)

System: **FV AQUA**
 Material: -
 Standard: -
 Details: Trough for a supporting lead of a pipe in spaces where you can not use clips.



						#			
16 × 2 m	pcs	25	2	0,29	0,26	AA987026002			
20 × 2 m	pcs	25	2	0,34	0,40	AA987020002			
25 × 2 m	pcs	25	2	0,44	0,63	AA987025002			
32 × 2 m	pcs	25	2	0,53	1,02	AA987032002			
40 × 2 m	pcs	20	2	0,62	1,60	AA987040002			
50 × 2 m	pcs	20	2	0,76	2,50	AA987050002			
63 × 2 m	pcs	15	2	0,90	3,97	AA987063002			
75 × 2 m	pcs	15	2	1,07	5,63	AA987075002			
90 × 2 m	pcs	10	2	1,11	5,63	AA987090002			

RPE pipe

System: **FV AQUA**
 Material: RPE
 Standard: -
 Details: Special pipe for connection to the flushing systems etc.



						#			
10/6	kg	1	1	1,00		AA988000000			

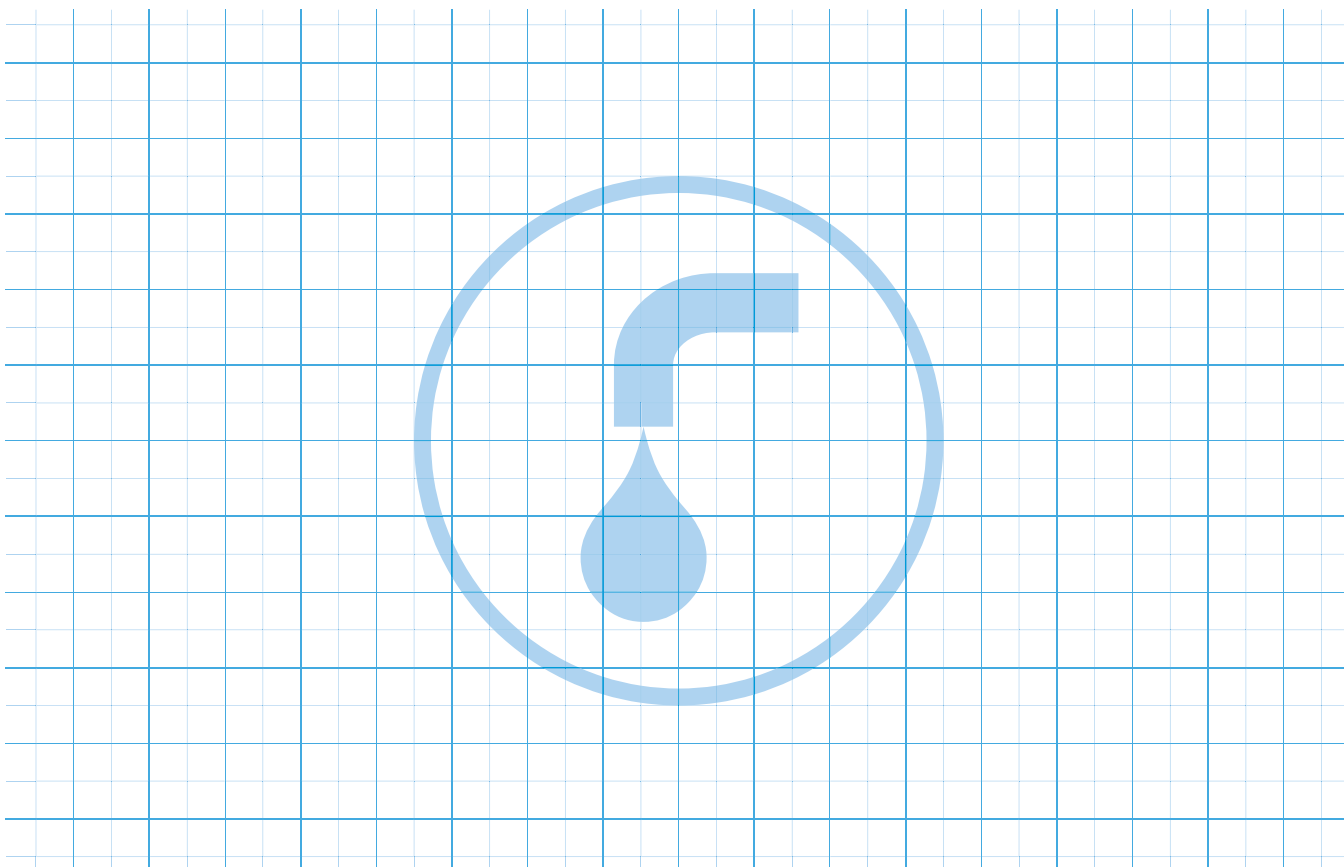



FV
PLAST®



SYSTEM PIPES FOR HEATING

FV MULTIPERT-5

System: **FV THERM**

Material: PE-RT/EVOH/PE-RT

Standard: EN ISO 22391, DIN 4726

Five-layer, highly flexible polyethylene pipe PE-RT II with high heat resistance (acc. to EN ISO 22391), with an oxygen barrier of ethylene vinyl alcohol (EVOH) according to DIN 4726.

T_{max} 95 °C.

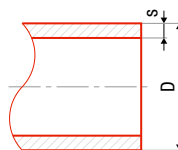

					dm^3	#	D [mm]	s [mm]	l [mm]
10 × 1,3	m	420	cardboard	0,040	0,297	AA120010420	10	1,3	420
12 × 1,5	m	300	cardboard	0,055	0,416	AA120012300	12	1,5	300
14 × 1,8	m	300	cardboard	0,076	0,416	AA120014300	14	1,8	300
15 × 1,8	m	200	cardboard	0,08	0,60	AA120015200	15	1,8	200
15 × 1,8	m	400	folie	0,08	0,60	AA120015400	15	1,8	400
16 × 2,0	m	200	cardboard	0,09	0,60	AA120016200	16	2,0	200
16 × 2,0	m	400	foil	0,09	0,60	AA120016400	16	2,0	400
17 × 2,0	m	200	cardboard	0,102	0,60	AA120017200	17	2,0	200
17 × 2,0	m	400	foil	0,102	0,60	AA120017400	17	2,0	400
18 × 2,0	m	200	cardboard	0,108	0,60	AA120018200	18	2,0	200
18 × 2,0	m	400	foil	0,108	0,60	AA120018400	18	2,0	400
20 × 2,0	m	200	cardboard	0,117	0,60	AA120020200	20	2,0	200

FV MULTIPEX-5

System: **FV THERM**

Material: PE-Xa/EVOH/PE-Xa

Standard: ČSN EN ISO 15875, DIN 4726

Five-layer, particularly resistant pipe of cross-linked polyethylene PE-Xa with increased heat resistance (acc. to ČSN EN ISO 15875), with an oxygen barrier of EVOH according to DIN 4726. T_{max} 110 °C.

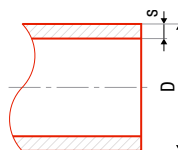

					dm^3	#	D [mm]	s [mm]	l [mm]
16 × 2,0	m	200	cardboard	0,090	0,60	AA121016200	16	2,0	200
16 × 2,0	m	400	foil	0,090	0,60	AA121016400	16	2,0	400
17 × 2,0	m	200	cardboard	0,100	0,60	AA121017200	17	2,0	200
17 × 2,0	m	400	foil	0,100	0,60	AA121017400	17	2,0	400
18 × 2,0	m	200	cardboard	0,110	0,60	AA121018200	18	2,0	200
18 × 2,0	m	400	foil	0,110	0,60	AA121018400	18	2,0	400
20 × 2,0	m	200	cardboard	0,125	0,60	AA121020200	20	2,0	200
20 × 2,0	m	400	foil	0,125	0,60	AA121020400	20	2,0	400

FV MULTIPERT-AL

System: **FV THERM**

Material: PE-RT/AL/PE-RT

Standard: ČSN EN ISO 15874, DIN 8077, DIN 8078

Five-layer, polyethylene pipe PE-RT II with an longitudinally welded aluminium layer. Increased heat resistance (acc. to EN ISO 22391). Oxygen barrier of aluminum according to DIN 4726. T_{max} 95 °C.

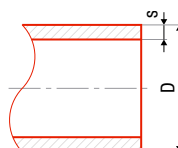

					dm^3	#	D [mm]	s [mm]	l [mm]
16 × 2,0	m	200	cardboard	0,105	0,60	AA130016200	16	2,0	200
16 × 2,0	m	400	foil	0,105	0,60	AA130016400	16	2,0	400
18 × 2,0	m	200	cardboard	0,123	0,60	AA130018200	18	2,0	200
20 × 2,0	m	200	cardboard	0,148	0,60	AA130020200	20	2,0	200

SYSTEM PLATES

FV EPS insulated mounting mate in roll

System: **FV THERM**
 Material: EPS
 Standard: EN 13163

Heat and sound insulation EPS base (according to DIN EN 13163) (WLS 045) with a grid patterned durable waterforof polyethylene membrane to prevent water and humidity leak. Grid enables easy pipe fixing with tacker staples and self-adhesive tape.

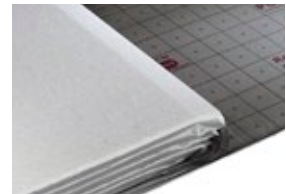

					#	for Ø D	pitch [mm]	netto area [m²/pcs]	flexibility resistance [kPa/m²]	therm.con. [W/m.K]
1 m × 10 m × 30 mm	m²	10	0,6	36,18	AA900010030	14 - 20		10,00	3,5	0,045

FV NOP UNI system mat

System: **FV THERM**
 Material: PS
 Standard: EN 13163

Universal mat of durable PS film with studs. For heating pipes with diameters 14 - 20 mm. Enables 38 mm or 75 mm spacing. Special rim for easy connection of mats.

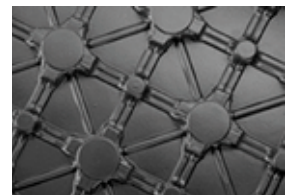

					#	for Ø D	pitch [mm]	netto area [m²/pcs]	capacity [kN/m²]	therm.con. [W/m.K]
1275 × 975 × 23 mm	pcs	18	1,31	18,20	AA901001000	14 - 20	75/38	1,08	unlimited	

FV NOP SOLO system mat

System: **FV THERM**
 Material: PS
 Standard: EN 13163

Universal mat of PS film with studs. For heating pipes with diameters of 14 - 18 mm. Special rim for easy connection of mats.



illustrative photo

					#	for Ø D	pitch [mm]	netto area [m²/pcs]	capacity [kN/m²]	therm.con. [W/m.K]
1025 × 1025 × 17 mm	pcs	20	0,975	10,92	AA902001000	14 - 17	50/70	1,00	unlimited	
1470 × 870 × 21 mm	pcs	14	1,286	16,56	AA902002000	14 - 17	60/84	1,20	unlimited	
1400 × 800 × 21 mm	pcs	180	0,975	10,92	AA902003000	16 - 18	50/70	1,12	unlimited	

FV NOP ISO system mat with 11 mm insulation

System: **FV THERM**
 Material: EPS/PS
 Standard: EN 13163

Combined thermal and sound insulation of EPS 11 mm with a layer resistant to deep-drawn PS foil formed into the shape of studs. A suitable mat for heating pipes with diameters of 16 - 18 mm, with a rim for easy connection to other mats. System mat for floor heating allows quick and easy installation with minimum of pruning.



					#	for Ø D	pitch [mm]	netto area [m²/pcs]	Max.traffic load [kN/m²]	therm.con. [W/m.K]
1400 × 800 × 11 mm	pcs	14	1,286	31,875	AA902002011	16 - 18	50/70	1,12	4,6	0,035

FV NOP ISO PLUS system mat with 30 mm insulation

System: **FV THERM**

Material: EPS/PS

Standard: EN 13163

Combined thermal and sound insulation of EPS 30 mm with a layer resistant to deep-drawn PS foil formed into the shape of studs. A suitable mat for heating pipes with diameters of 16 -18 mm, with a rim for easy connection to other mats. System mat for floor heating allows quick and easy installation with minimum of pruning.



						for Ø D	pitch [mm]	netto area [m ² /pcs]	Max.traffic load [kN/m ²]	therm.con. [W/m.K]
1400 × 800 × 30 mm	pcs	8	1,75	57,08	AA902001030	16 -18 mm	50	1,12	5	0,035

FV TBS system mat with 25 mm insulation for dry construction

System: **FV THERM**

Material: EPS

Standard: EN 13163

A special system for dry construction of floor heating. Thermal insulation board made of 25 mm EPS for inserting guide plates and reversing arcs. A suitable mat for heating pipes with diameter 14 mm, with a rim for easy connection to other mats. System mat for floor heating allows quick and easy installation with minimum of pruning.



						for Ø D	pitch [mm]	netto area [m ² /pcs]	capacity [kN/m ²]	therm.con. [W/m.K]
1020 × 645 × 25 mm	pcs	21	0,476	17,35	AA903001025	14	125	0,625	6	0,035

FV TBS L guide plate

System: **FV THERM**

Material: Fe/Zn

Standard: -

Metallic guide plate insert to FV TBS system mat. For heating pipes with 14 mm diameter



						for Ø D	pitch [mm]			
750 × 120 mm	pcs	50	0,44	0,862	AA903002000	14	125			

FV TBS C reversing arc for mats FV TBS

System: **FV THERM**

Material: Fe/Zn

Standard: -

Metallic arc insert to FV TBS system mat. For heating pipes with 14 mm diameter.



						for Ø D	pitch [mm]			
245 × 125 mm	pcs	25	0,141	0,466	AA903003000	14	125			

FV RENO special mat for floor reconstruction

System: **FV THERM**

Material: PS

Standard: EN 13163

A low-height mat made of PS with studs. Designed for the floor heating instalations on original old floors. For heating pipes with diameter of 10-12 mm.

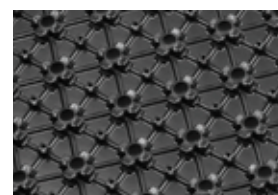

						for Ø D	pitch [mm]	netto area [m ² /pcs]	capacity[kN/m ²]	therm.con. [W/m.K]
1050 × 650 × 16 mm	pcs	16	0,84	11,44	AA904001000	10 - 12	50/43	0,60	unlimited	

FV clamping rail

System: **FV THERM**
 Material: PP
 Standard:

A Clamping rail for easy laying of system pipes with height fixation and adhesive tape for quick fixing to the base. Minimum span of pipes 50 mm, length 1000 mm. Universal for pipes with diameters of 16-20 mm.

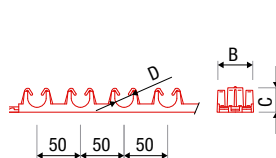

					#	D [mm]	B [mm]	C [mm]
16 - 20 × 1000 mm	pcs	100	1,168	0,83	AA905003000	16 - 20	40	28

FV staple for clamping rail

System: **FV THERM**
 Material: PP
 Standard:

Staple for fixing a universal clamping rails. Staple securely holds the clamping rail in the EPS mats even when used in dusty spaces. It delivers in white color.

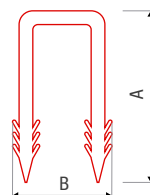

					#	D [mm]	A [mm]	B [mm]
	pcs	200	0,002	0,009	AA909000058		58	27

MANIFOLD

FV manifold with flowmeter

System: **FV THERM**
 Material: brass
 Standard: -

Complete heating manifold with flowmeters. Distributor and collector are made of 50 mm diameter solid brass profiles with 1" AG connections, optionally left or right. The distributor is equipped with adjustable and lockable, always clear, dry flow meters with a scale of 0.1 to 4 l/min for precise tuning of the water flow into the individual heating sections. The collector is equipped with shut-off valves ready for the usage of termodrives with ON/OFF function. The distributor and collector are mounted on a soundproof concole at different depth for easier connection of the pipes.

The set includes the filling and drain ball valves with 1/2" connection, manual air bleeding valves, labels.

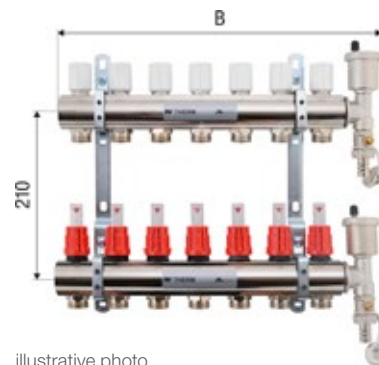

illustrative photo

					#	B [mm]
150 mm	pcs	1	1,50	6,0	AA906000002	2 circuits 150
200 mm	pcs	1	1,80	6,0	AA906000003	3 circuits 200
250 mm	pcs	1	2,00	6,0	AA906000004	4 circuits 250
300 mm	pcs	1	2,50	8,0	AA906000005	5 circuits 300
350 mm	pcs	1	3,00	8,0	AA906000006	6 circuits 350
400 mm	pcs	1	3,50	8,0	AA906000007	7 circuits 400
450 mm	pcs	1	4,00	10,0	AA906000008	8 circuits 450
500 mm	pcs	1	4,50	10,0	AA906000009	9 circuits 500
550 mm	pcs	1	5,00	10,0	AA906000010	10 circuits 550
600 mm	pcs	1	5,50	10,0	AA906000011	11 circuits 600
650 mm	pcs	1	6,00	10,0	AA906000012	12 circuits 650

FV manifold INOX

System: **FV THERM**
 Material: brass
 Standard: -

Complete heating manifold with flowmeters. Distributor and collector are made of 50 mm diameter solid brass profiles with 1" AG connections, optionally left or right with automatic venting and ball valve 1/2" for filling and draining. The distributor is equipped with adjustable and lockable, always clear, dry flow meters with a scale of 0.1 to 4 l/min for precise tuning of the water flow into the individual heating sections. The collector is equipped with shut-off valves ready for the usage of termodrives with ON/OFF function.



Q ₁₁₁	⊕	⊞		⊞	dm ³	#		B [mm]	
150 mm	pcs	1		2,8	10,1	AA906001002	2 circuits	150	
200 mm	pcs	1		3,3	10,1	AA906001003	3 circuits	200	
250 mm	pcs	1		3,7	10,1	AA906001004	4 circuits	250	
300 mm	pcs	1		4,2	12,5	AA906001005	5 circuits	300	
350 mm	pcs	1		4,6	14,9	AA906001006	6 circuits	350	
400 mm	pcs	1		5,0	14,9	AA906001007	7 circuits	400	
450 mm	pcs	1		5,5	17,3	AA906001008	8 circuits	450	
500 mm	pcs	1		5,9	17,3	AA906001009	9 circuits	500	
550 mm	pcs	1		6,3	19,7	AA906001010	10 circuits	550	
600 mm	pcs	1		6,8	19,7	AA906001011	11 circuits	600	
650 mm	pcs	1		7,1	19,7	AA906001012	12 circuits	650	

FV manifold with flowmeter plastic

System: **FV THERM**
 Material: plastic, brass
 Standard: -

Plastic manifold made of black resistant polymer with a spacing of 50 mm and connected to a 1" AG power supply. With excellent temperature resistance, max 90 °C at 3 bar pressure and minimum temperature expansion. For water and glycol heating fluids with a max.concentration of 50 %. Working temperature from 5 to 55 °C. Working pressure 0 – 6 bar. There are dry flowmeters with a scale from 0 to 5 l/min. The return circuits are fitted with shut off valves with the possibility of connecting a M30 x 1,5 mm thermal actuator. In set with adjustable holders with spacing from 200 to 250 mm. The total thickness of the manifold including the bracket for wall or cabinet mounting is 75 mm.



Q ₁₁₁	⊕	⊞		⊞	dm ³	#		B [mm]	
150 mm	pcs	1				AA906002002	2 circuits	150	
200 mm	pcs	1				AA906002003	3 circuits	200	
250 mm	pcs	1				AA906002004	4 circuits	250	
300 mm	pcs	1				AA906002005	5 circuits	300	
350 mm	pcs	1				AA906002006	6 circuits	350	
400 mm	pcs	1				AA906002007	7 circuits	400	
450 mm	pcs	1				AA906002008	8 circuits	450	
500 mm	pcs	1				AA906002009	9 circuits	500	
550 mm	pcs	1				AA906002010	10 circuits	550	
600 mm	pcs	1				AA906002011	11 circuits	600	
650 mm	pcs	1				AA906002012	12 circuits	650	

MIXING SETS

FV mixing set for 200 m²

System: **FV THERM**
 Material: brass
 Standard: -

Mixing set for underfloor heating with heating surface up to 200 m². The set contains thermoregulation valve, thermostatic head with thermal range 20 - 43 °C., sensor, circulation pump Wilo Star RS 15/6, three-way valve, By-pass, thermometer in the manifold inlet. Connection 1".

					#	B [mm]
	pcs	1	4,1	10,50	AA906100200	219



FV mixing set for 160 m²

System: **FV THERM**
 Material: brass
 Standard: -

Mixing set for underfloor heating with heating surface up to 160 m². The set contains thermoregulation valve, thermostatic head with thermal range 20-65 °C, sensor, circulation pump Wilo Star RS 15/6, back flow valve, By-pass regulation valve, electronic control unit of pump, thermometer. Connection 1".

					#	B [mm]
	pcs	1	4,5	12,70	AA906100160	194

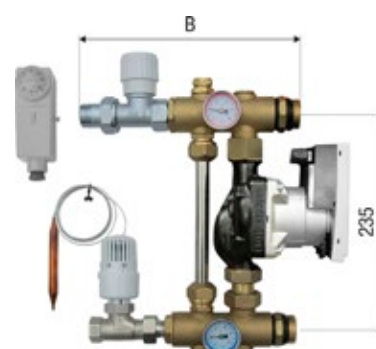

VALVES AND A THERMOMETERS

FV ball valve 1" with male and female thread

System: **FV THERM**
 Material: Forged brass body according to EN 12165, nickel.
 Standard: ČSN EN ISO 228
 Ball valve with connection 1" and colored butterfly handle.
 Field of use -10 °C to +95 °C.

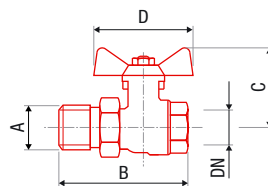

					#	#	A	B [mm]	C [mm]	D [mm]	
1"	pcs	72	6	0,53	0,36	AA926001001		1"	88	57	67
1"	pcs	72	6	0,53	0,36		AA926002001	1"	88	57	67

FV thermometer for manifold

System: **FV THERM**
 Material: -
 Osazení: On the body of manifold
 Thermometer for measuring input and output temperature on manifold. Field of use min. 0 °C to 120 °C.

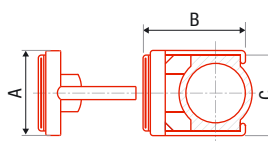

					#	#	A [mm]	B [mm]	C [mm]
1"	pcs		1	0,03	0,09	AA927000001	Ø 45,5	55	40,8
1"	pcs		1	0,03	0,09	AA927000002	Ø 45,5	55	40,8

BOXES

FV manifold cabinet on plaster

System: **FV THERM**

Material: -

Standard: -

Made of steel sheet, covered with white paint. Rear panel with supporting arm for mounting the distributor, depth 130 mm, removable and lockable door.



QTY	UNIT	W	H	W	H	W	dm ³	#			
450 mm	pcs	1	1	5,80	39,00			AA907000045			
530 mm	pcs	1	1	6,20	46,00			AA907000053			
680 mm	pcs	1	1	7,50	59,00			AA907000068			
830 mm	pcs	1	1	9,20	72,00			AA907000083			
1030 mm	pcs	1	1	10,00	89,00			AA907000103			

FV manifold cabinet under plaster

System: **FV THERM**

Material: -

Standard: -

Made of steel sheet, covered with white paint. Rear panel with supporting arm for mounting the distributor, the depth of 100 mm. Adjustable above-floor height. Removable and lockable door.



QTY	UNIT	W	H	W	H	W	dm ³	#			
450 mm	pcs	1	1	6,10	41,00			AA908000045			
530 mm	pcs	1	1	6,70	47,00			AA908000053			
680 mm	pcs	1	1	7,80	60,00			AA908000068			
830 mm	pcs	1	1	9,90	72,00			AA908000083			
1030 mm	pcs	1	1	11,00	89,00			AA908000103			

ACCESSORIES

FV tacker staple

System: **FV THERM**

Material: PP

Standard: -

High quality harpoon-shaped staples for fixing 15 - 20 mm pipes onto the FV EPS system roll. Stacked by 50 pcs for easy staple gun filling.



QTY	UNIT	W	H	W	H	W	dm ³	#			
40 mm	pcs	1	300	0,0018	0,010			AA909000040			
50 mm	pcs	1	250	0,0021	0,013			AA909000050			

FV edge belt

System: **FV THERM**

Material: PE

Standard: -

Special mounting area edge belt made of 8 mm thick and 150 mm height polyethylene foam (PE) with 180 mm wide polyethylene film attached.



QTY	UNIT	W	H	W	H	W	dm ³	#			
150 mm	m	400	25	1,00	15,00			AA910150050			

FV PE protecting tube

System: **FV THERM**

Material: PE

Standard: -

Polyethylene (PE) protective tube designed to protect the heating pipes running through the dilatation joints and to the manifold.



Q ₁₁₁	⊕	⊞	⊞	⊞	dm ³	#			
24 mm × 50 m	pcs		50 m	6,00	0,35	AA911024050			

FV dilatation belt

System: **FV THERM**

Material: PE

Standard: -

For safe separation of dilatating floor segment and creating long elastic dilatation joints. Made of 10mm thick polyethylene foam (PE) core, height 100 mm, length 2000 mm.



Q ₁₁₁	⊕	⊞	⊞	⊞	dm ³	#			
100 × 2000 mm	m	220	2	0,07	2,236	AA912100200			

FV direction diverter

System: **FV THERM**

Material: -

Standard: -

Direction diverter adjustable 0 - 90°. Designed to divert the heating pipes passing through the ceiling or rising to the manifold.



Q ₁₁₁	⊕	⊞	⊞	⊞	dm ³	#	D [mm]	length [mm]	
20	pcs	50	1	0,056	0,64	AA913020001	20	250	

FV direction diverter "click"

System: **FV THERM**

Material: -

Standard: -

A direction diverter click 0 - 90° for protection and fixing pipes to pass trough ceiling and input to manifold.



Q ₁₁₁	⊕	⊞	⊞	⊞	dm ³	#	D [mm]	length [mm]	
15	pcs	25	1	0,060	0,116	AA913015000	15	150	
16 - 17	pcs	25	1	0,060	0,116	AA913017000	16 - 17	153	
18 - 20	pcs	80	1	0,060	0,122	AA913018020	18 - 20	175	

FV fixing plastic bend

System: **FV THERM**

Material: -

Standard: -

A bend 90° for protection and fixing pipes to pass trough ceiling and input to manifold. Universal for diameters 14 - 18 mm and 20 - 22 mm.



Q ₁₁₁	⊕	⊞	⊞	⊞	dm ³	#	D [mm]	length [mm]	
14 - 18	pcs	400	1	0,04	0,26	AA913014018	14 - 18	160	
20 - 22	pcs	400	1	0,06	0,55	AA913020022	20 - 22	160	

FV self-adhesive tape

System: **FV THERM**

Material: -

Standard: -

Durable self-adhesive tape 50 mm width, 60 m length.



Icon	⊕	⊞	⊞	⊞	⊞	#			
50 mm x 60 m	pcs	10	1	0,01	0,10	AA914050060			

FV screed plasticizer

System: **FV THERM**

Material: -

Standard: -

A special additive for preparing the screed with good elasticity and high mechanical strength.



Icon	⊕	⊞	⊞	⊞	⊞	#			
5 l	pcs		1	5,00	5,00	AA915005000			

CONTROL

FV servodrive

System: **FV THERM**

Material: -

Standard: -

For heating systems with thermostatic control. Designed for integration into the heating valve (in the manifold) with position indicator "open / closed".



Icon	⊕	⊞	⊞	⊞	⊞	#			
230 V	pcs	50	1	0,14	0,30	AA916000000			

FV thermostatic controller

System: **FV THERM**

Material: -

Standard: -

Electronic single room temperature controller. To be used in combination with servo drives.



Icon	⊕	⊞	⊞	⊞	⊞	#			
230 V	pcs		1	0,20	0,10	AA917000000			

FV electronic switching module

System: **FV THERM**

Material: -

Standard: -

Electronic switching module for connecting up to 24 servodrives and 6 thermostatic controllers. To be mounted on DIN rail.



Icon	⊕	⊞	⊞	⊞	⊞	#			
24 - 230 V	pcs		1	0,40	3,00	AA918000000			

FV transformer 230/24 V

System: **FV THERM**

Material: -

Standard: -

Safety transformer 230 V AC / 24V AC. Short-circuit protection, with built-in thermal fuse.



						#			
230/24 V	pcs		1	2,00	1,00	AA919000000			

FV flowmeters

System: **FV THERM**

Material: -

Standard: -

--



illustrative photo

						#	G	B [mm]	C [mm]
	pcs	1		0,038	0,014	AA906999000	1/2"	7	100
INOX	pcs	1		0,038	0,014	AA906998000	1/2"	7	121,6

JOINS

FV transition union to the distributor (Eurocone 3/4")

System: **FV THERM**

Material: -

Standard: -

Threaded connector for connecting FV MULTIPERT and FV MULTIPLEX heating pipes to the manifold.



						#			
10 × 1,3	pcs		10	0,10	0,03	AA920010000			
12 × 1,5	pcs		10	0,10	0,03	AA920012000			
14 × 1,8	pcs		10	0,10	0,03	AA920014000			
15 × 1,8	pcs		10	0,10	0,03	AA920015000			
16 × 2,0	pcs		10	0,10	0,03	AA920016000			
17 × 2,0	pcs		10	0,10	0,03	AA920017000			
18 × 2,0	pcs		10	0,10	0,03	AA920018000			
20 × 2,0	pcs		10	0,10	0,03	AA920020000			

FV coupling

System: **FV THERM**

Material: -

Standard: -

Reliable brass coupling. It consists of a dual MS threaded connection and two transition unions for connecting the pipes.



Q ₁₁₁	+	+	+	+	dm ³	#			
10 x ..	pcs			10	0,10	0,07	AA921010000		
12 x ..	pcs			10	0,10	0,07	AA921012000		
14 x 1,8	pcs			10	0,10	0,07	AA921014000		
15 x 1,8	pcs			10	0,10	0,07	AA921015000		
16 x 2,0	pcs			10	0,10	0,07	AA921016000		
17 x 2,0	pcs			10	0,10	0,07	AA921017000		
18 x 2,0	pcs			10	0,10	0,07	AA921018000		
20 x 2,0	pcs			10	0,10	0,07	AA921020000		

FV reducing sleeve male 3/4"

System: **FV THERM**

Material: brass - nickel

Reducing sleeve for connection of MULTI pipes to transition union Euroconus 3/4". Field of use min. 0 °C - 95 °C

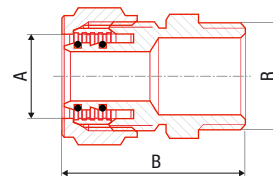

Q ₁₁₁	+	+	+	+	dm ³	#	A	B [mm]	R
15 x 3/4"	pcs	1	1	0,085	0,135	AA924015034	15	38	3/4"
16 x 3/4"	pcs	1	1	0,088	0,135	AA924016034	16	40	3/4"
17 x 3/4"	pcs	1	1	0,090	0,135	AA924017034	17	40	3/4"
20 x 3/4"	pcs	1	1	0,111	0,135	AA924020034	20	43	3/4"

FV plug female 3/4"

System: **FV THERM**

Material: brass - nickel

Fixing: closing branches of manifold

For closing non-use branches of manifold, the possibility of establishing reserves for future expansion. Field of use min. 0 °C - 120 °C.

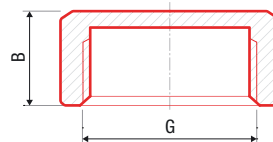

Q ₁₁₁	+	+	+	+	dm ³	#	G	B [mm]	
3/4"	pcs			1	0,034	0,027	AA925020034	3/4"	12

ACCESSORIES

FV Tacker - fixing gun

System: **FV THERM**

Material: -

Standard: -

Tucker 15 - 20 - special fixing tool for fixing pipes on the mats. Height-adjustable, for fixing pipes using the original harpoon-staples.



Q ₁₁₁	+	+	+	+	dm ³	#			
15 - 20	pcs			1	7,00	15,00	AA922000000		

FV Tacker - fixing gun plastic

System: **FV THERM**

Material: -

Standard: -

Tucker 15 - 20 - special fixing tool for fixing pipes on the mats. Height-adjustable, for fixing pipes using the original harpoon-staples.



						#			
15 - 20	pcs		1	1,75	22,30	AA922000001			

FV horizontal decoiler

System: **FV THERM**

Material: Fe - galvanized iron

Standard: -

For unwinding of the heating pipes up to the length of 600 meters. Maximum load 90 kg, the maximum coil diameter of about 260 mm, a maximum width of 420 mm.



						#	Ø [mm]	height [mm]	
14 - 20	pcs		1	16,00	45,29	AA923001000	1140	548	

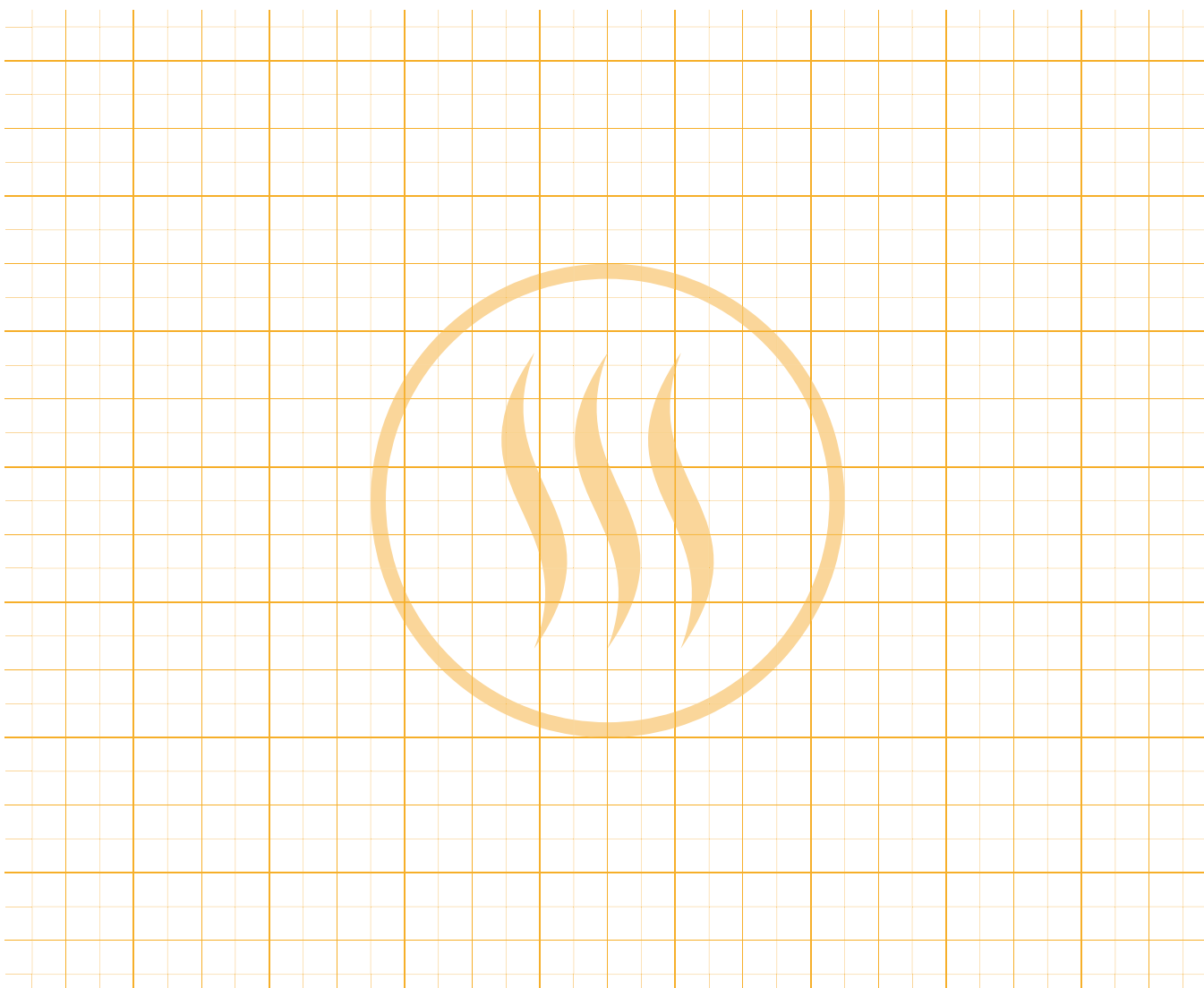

ASSEMBLY INSTRUCTIONS FOR UNDERFLOOR HEATING SYSTEM

FV THERM underfloor heating system is designed for apartments, family houses, administrative and shopping centers and industrial buildings heating. The system is based on FV MULTIPERT-5 and FV MULTIPLEX-5 quality pipes with EVOH oxygen barrier specially designed for the underfloor heating, their usage is the most economic for this purpose. FV MULTIPERT-AL with a lengthwise welded aluminium layer quality pipes can be used as well.

The FV THERM underfloor heating system is classified as a system for flooring in wet conditions in a construction implementation A group as per DIN 18560-2 on the basis of the arrangement of FV MULTIPLEX-5 and FV MULTIPERT-5 heating pipes on an insulation layer.

Figure 1: Construction implementation A - Pipes in topping systems

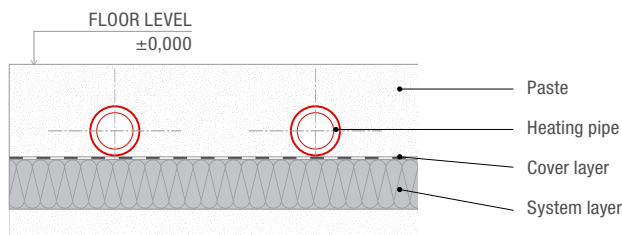
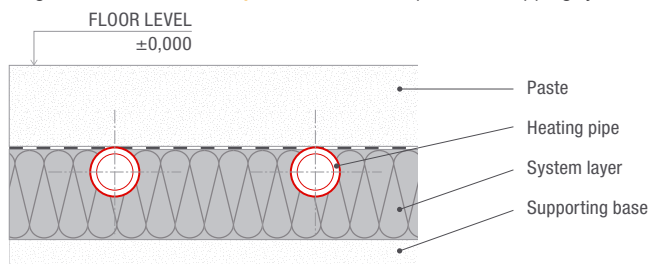

Figure 2: Construction implementation B - Pipes under topping systems



1. FIELDS AND DILATATION JOINT SIZES

A topping is realized as per DIN 18560-1. Topping additives can be used for a better cement toppings processing. The size of topping sand grains should be between 0 – 8 mm. Topping fields of 1:1 or 1:2 joints ratio should not exceed 40 m². See figure 3 for a dilatation fields and joints arrangement. Regarding the areas smaller than 40 m², the dilatation joints should be used if the side size exceeds 8 m or the sticking out construction parts (corners, pillars, chimneys) limit the shape of a topping sheet.

The dilatation joints can be crossed using only connecting line in one level via a minimum of 200 mm long protecting pipe for each joint side.

Three measure points are required for each topping area of 200 m² to measure residual moisture. Heating circuit designing must have the size and shape of the topping sheet (see figure 3). Regarding the anhydrite poured toppings, the joint arrangement has to be consulted with a topping producer.

The construction joints and the joints in the topping (motion joints) and in the final flooring have to be done. The topping is separated from vertical construction parts by the joints (marginal joints). If the contraction joints are in the heating toppings, they can be notched to one third of topping size maximum. A joint plan about the joints arrangement has to be made to inform about the type and arrangement of joints. The plan is made by a construction draftsman and presented as a part of realizing company performance descriptions.

Figure 3: Fields and dilatation joints arrangement

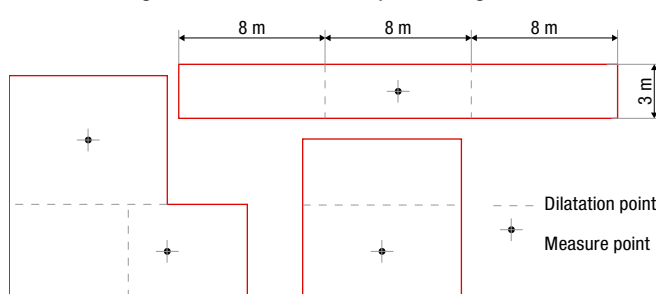

Figure 4: Heating paste dilatation joint

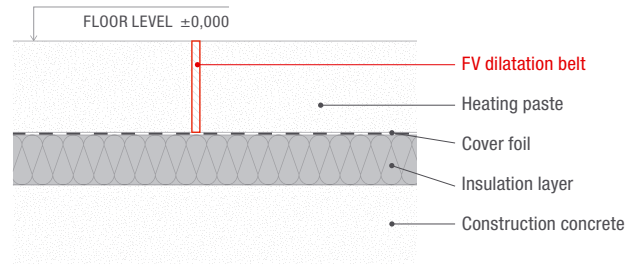

Figure 5: Heating paste dilatation belt when laying hard flooring (floor tiling, stone floor, laminate floor)

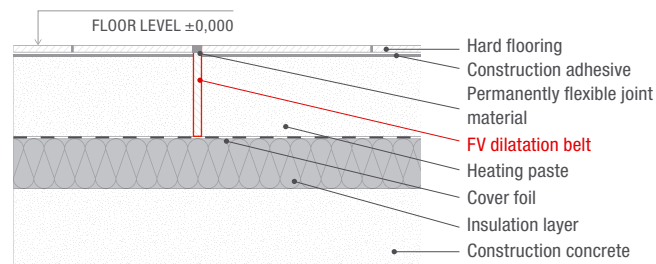

Figure 6: Heating paste dilatation belt when laying hard flooring with division layer (floor tiling, stone floor, laminate floor)

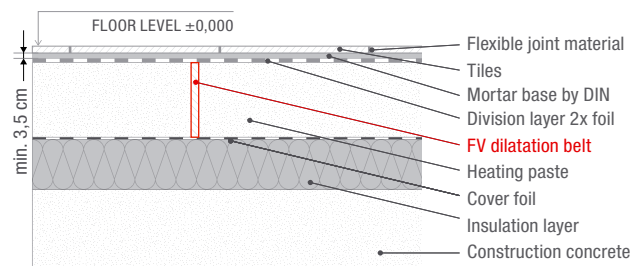
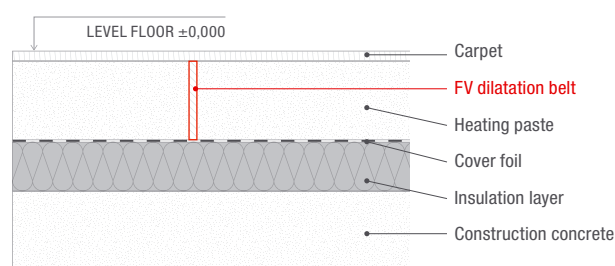

Figure 7: Heating paste dilatation belt when laying soft flooring (PVC, linoleum, carpet)



The dilatation joints are made in accordance with the joint plan. A construction dilatation joint is made without any cut also in the place of underfloor heating if there is one already. If the hard flooring is used, it is necessary to add the dilatation joint to this layer (see figure 5).

Protect the heating pipe when crossing danger zones (dilatation joints, door crossings, wall passages) by placing it into a FV PE protecting tube.

Only the intake and returnable pipes leading to individual circuits placed in sleeve can be put over the dilatation joint, not the circuit pipes. The minimum length of pipe sleeve (see figure 8) is 20 cm on each dilatation joint side. The minimum width of the dilatation joint is 8 mm.

Figure 8: Protection of heating pipe when crossing dilatation belt by FV PE protecting tube

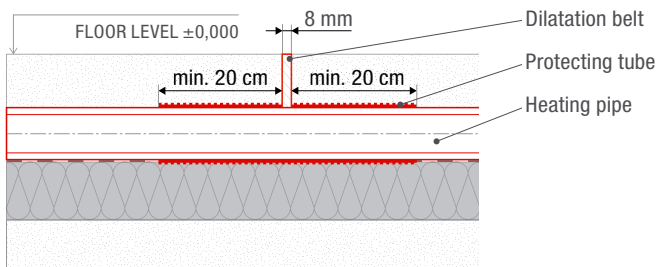

2. UNDERFLOOR HEATING PIPES

FV MULTIPERT-5 and FV MULTIPLEX-5 pipes belong to high-quality, controlled and certified products. After receiving plastic pipes on a construction site, transport, store and process them so that:

- they are protected against any damage
- heating pipes are not under direct sunlight
- storage period does not exceed 3 months during unprotected storage
- they are stored on a flat base without any sharp edges
- they are protected against oils, fats, colors and longer effect of sunlight

Polyethylene heating pipes FV MULTIPERT-5

Permanent operating temperature:	+ 70 °C
Maximal short-time thermal load:	+90 °C (maximum of 2 years)
Operating pressure:	4 bar
Meets all requirements of ISO 10508 norm for 4+5 class	
Minimal bend radius:	5xd (d= inner diameter)
Installation temperature:	from -5 °C to + 30 °C
DIN Registration number:	3V 204 PE-RT

The 5-layer highly flexible PE-RT system pipe has enhanced thermal resistance as per EN ISO 22391, with the oxygen barrier as per DIN 4726, with enhanced protection against mechanical damage during transport and handling on the construction site. Package contains 200m in taped bundle in cartons. Package weight is approximately 25 kg.

The permeability of oxygen at 40°C is deep under DIN 4726 limit. Using the HP method, the EVOH barrier layer is inseparably connected to the PE-Xa basic pipe with enhanced thermal resistance, highly flexible, from a webbed polyethylene.

Polyethylene heating pipes FV MULTIPLEX-5

Permanent operating temperature:	+ 95 °C
Maximal short-time thermal load:	+ 110 °C (maximum of 2 years)
Operating pressure:	6 bar
Meets all requirements of ISO 10508 norm for 4+5 class	
Minimal bend radius:	5xd (d= inner diameter)
Installation temperature:	from -5 °C to + 30 °C
DIN Registration number:	3V 235 PE-Xa

The 5-layer highly flexible webbed polyethylene PE-Xa pipe has enhanced thermal resistance as per EN ISO 15875, with the oxygen barrier as per DIN 4726, with enhanced protection against mechanical damage during transport and handling on the construction site. Package contains 200 m in taped bundle in cartons. Package weight is approximately 25 kg.

The permeability of oxygen at 40°C is deep under DIN 4726 limit. Using the HP method, the EVOH barrier layer is inseparably connected to the basic pipe.

2.1. UNDERFLOOR HEATING ASSEMBLY STEPS IN FV THERM SYSTEM

Electric and sanitary installations, inner plasters and windows need to be finished before the installation of insulations and square heating. Plasters need to be plastered closely to the supportive base. An expert has to check the flatness of a row floor using a meter score before the installation of the underfloor heating system. Maximal altitude tolerance is 1cm on the entire installation room area. The meter scores are usually marked by a circle or other way at door spreads during the construction. Size tolerances are met as per DIN 18202 (ground constructions tolerance). The flatness needs to be checked before installing the insulation. Possible unevenness needs to be removed or flattened. The remaining plaster and other dirt need to be removed from the floor.

Figure 9 Underfloor heating pipes layout



Ground bordering floor areas need to be insulated against moisture as per DIN 18195 (construction insulation). Accurate construction insulation execution definition is made by a draftsman or architect. A craftsman doing the insulation layout has to check sealing suitability and communicate in writing possible concerns about hydro insulation to construction administration. If a bitumen sealing assembly is done, of e.g. bitumen belts, it is necessary to lay a 0.1mm thick polyethylene innerlayer before the insulation layout. A foil is laid freely on the sealing. The pipes on the floor need to be properly fastened and secured against movement. The equalizing insulation needs to be laid to reach the floor proper structure. Another insulation layer can be put on the lower insulation. Only the "hard" insulation (EPS-DEO, PUR, ...) can be used for the equalizing insulation. The multi-layer insulation individual layers joints cannot overlap but alternate (see figure 11).

3.1. FV THERM MARGINAL INSULATION BELT ASSEMBLY

The marginal insulation belt needs to be properly done on every vertical construction part such as pillars, door openings, fireplace, elevator shaft and so forth. The marginal belt can be installed before laying the last insulation layer regarding the multi-layer construction thermal insulation. The marginal belt attached foil needs to be put so that the marginal joint between thermal and impact sound insulation is perfectly covered and the topping or water will not get into it. The marginal joints need to reach from the supporting base to the flooring surface and enable the minimal movement of 5mm regarding the heating toppings. The marginal belt has to be secured against movement when installing the topping. The insulation marginal belt situated above the topping sheet after being poured over can be removed only after top floor layer final laying to prevent the formation of an acoustic bridge or construction damage.

Also, the pointing has to be finished before removing the rest of the insulation marginal belt. Afterwards, floor socle slats are fitted.

Figure 10: FV marginal belt fitting

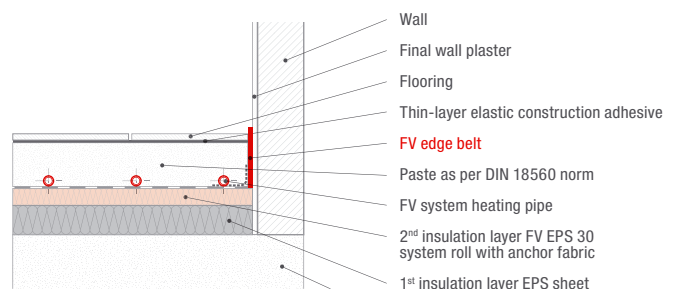

3.2. FV THERM SYSTEM SHEETS LAYOUT

The system sheets choice depend on the thermal and impact sound insulation requirements as per ENEC / DIN 4109 / DIN 4108 norms. The insulation layers and system sheets layout is on the flat supporting base. If installation or electric lines are put on the raw floor, they need to be preserved and a space for them has to be created under the underfloor heating insulation.

The multi-layer insulation first layer needs to be adjusted so that the whole-area base and current closed area are formed for the EPS system roll / the system sheets. Regarding the two-layer layout, the layers assembly has to be done with surpassing joints. The multi-layer sandwich foil on the upper side of system rolls / sheets is the insulation layer cover layer as per DIN 18560.

A unilateral foil overlap serves as the expansion joints covering. The front expansion joints needs to be glued with a FV tape only. Filling parts inserted without the foil overlap need to be taped. It is necessary to tape properly before using the poured topping to prevent the topping or water getting into it. The dilatation joint needs to be preserved on the buildings. The floor maximal allowed assembly height has to be

Figure 11: Multi-layer insulation layout under the underfloor heating

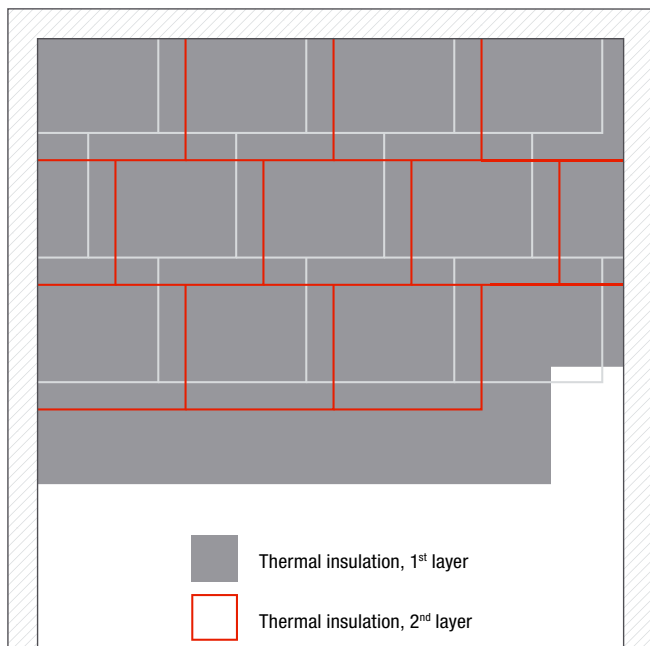

3.3. Underfloor heating distributor cabinet fitting

Floor circuit distributors are fitted into cabinets. Beside the distributor, there are closing globe valves and system inflating and air bleeding valves in the cabinet. There are also regulation components or a pump or blending. The cabinet is fitted before the circuit assembly. The FV cabinet can be placed under the plaster if the wall is thick enough; if the wall is not thick enough, the FV cabinet is fitted on the wall.

3.4. FV THERM heating pipes layout

The pipes layout starts with heating pipes fastening on the intake distributor. When tightening screws (size 30), it is important to hold a counterpart (size 24) on the distributor. Tightening moment is limited to 30N. The pipes edges have to be separated under right angle. The floor to wall crossing place is protected by putting the pipe into FV click guide piece enabling to fix the curve ranging between 0 – 90 °C.

Attaching the pipes to FV EPS system roll area is done using a FV tacker clips and an original FV system stable gun. FV tacker clips are placed in the spacing of approximately 50 cm if the heating pipes are straight, the spacing of approximately 30 cm is used when changing direction. Alternatively, it is possible to put the fastening slats on the insulation and the pipes put into them.

Keeping the following spacing is needed for layout:

- Vertical construction parts: 50 mm
- Elevators, shafts, chimneys, fireplaces: 200 mm

Figure 12: Counter flow piping layout

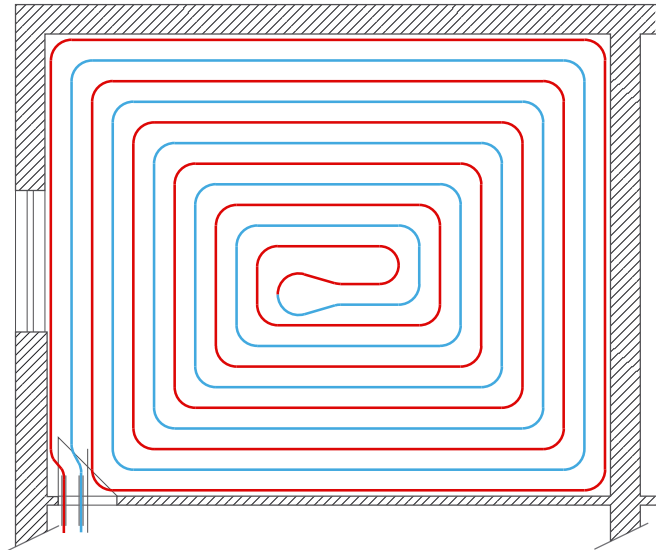
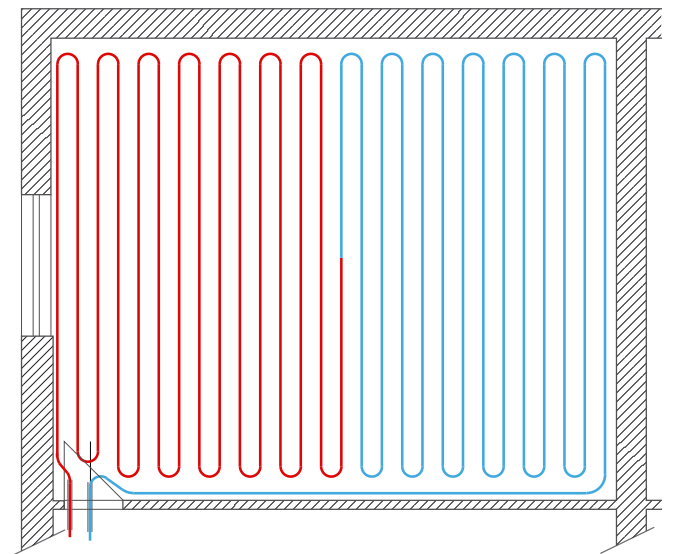

Figure 13: Serpentine piping layout



The 5 x r minimal bent ratio (pipes inner diameter) cannot be reduced as per DIN 4726 norm. The heating pipes layout can be serpentine or counter flow.

Regarding the even heat dispersion, the serpentine layout is preferred as it creates a constant course of floor temperatures. Pipes with smaller spacing than in a living part are laid in the cooler places (the northern wall with a large window or the glass wall) and the marginal zone which is either a part of the circuit or a part of the separate circuit is created.

Regarding the turning loops layout in the middle of the heating circuit, it is necessary to keep the minimal size corresponding with bent ratios as per DIN 4726. The minimal bent ratio is 75 mm for 15 x 1,8 mm pipe, 85 mm for 17 x 2,0 mm pipe. See figure 14 in case of sharp bent, $r = 17 \times 5 = 85$ mm, loop length 197 mm, width 170 mm valid for 17 x 2,0 pipe.

Figure 14:

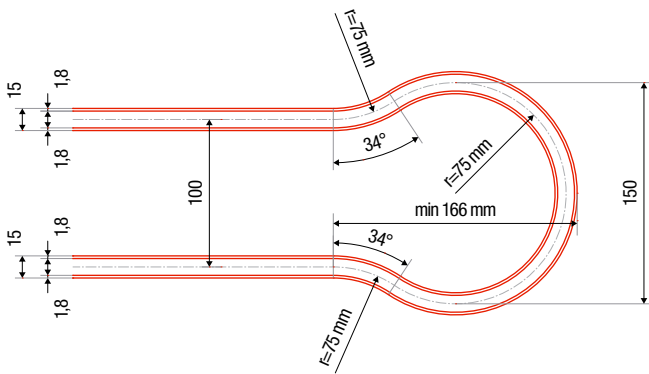

Sharp bent places formed after the violation of pipe's minimal ratio have to be removed. The clips can be assembled only on the straight lines of the pipes. The marginal pipe is put approximately 5 cm away from the marginal belt on the PE foil forming the part the marginal belt. Fastening the first pipe to the base ensures that grout will not leak under the foil.

The FV clip should be placed on the straight lines of the pipes not in the bent in case of the heating pipe repair or the processing of remaining lengths. The pipe clip has to be measured and marked in the construction documentation.

FLOOR SURFACE TEMPERATURES

Figure 15: Temperature curve. Comparing "ideal heating" to FV THERM underfloor heating

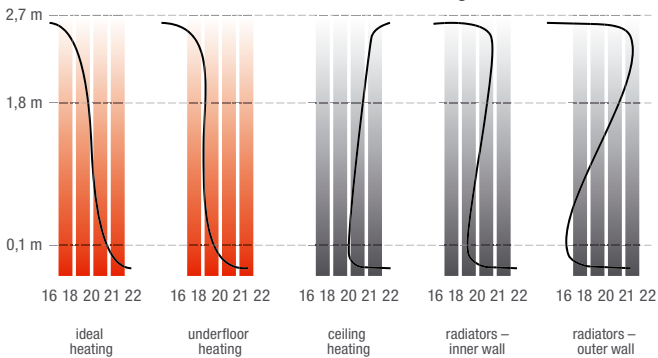

Deciding factor for the maximal surface temperature stipulation is the usage of a room. The maximal floor surface temperature is restricted to 29 °C in the living area (wet rooms 33 °C / the marginal zone 35 °C) as per DIN EN 1264. The chosen flooring decides the surface temperature or the even distribution of the underfloor heating surface temperature.

The even distribution of temperature is decided by its heat permeability resistance, heating means excessive temperature, heating pipes layout spacing and layout type.

Living area floor surface temperatures in case of corresponding outer temperatures								
V ₂ [°C]	-15	-10	-5	±0	+5	+10	+15	+20
v ₁ [°C]~	+29,0	+27,5	+26,0	+25,0	+24,0	+23,0	+21,5	+20,0

FV THERM SYSTEM UNDERFLOOR HEATING FLOOR STRUCTURE

Figure 16: Recommended floor structure above heated rooms as per CSN EN 1264 norm, insulation heat resistance R = 0,75 m²K/W

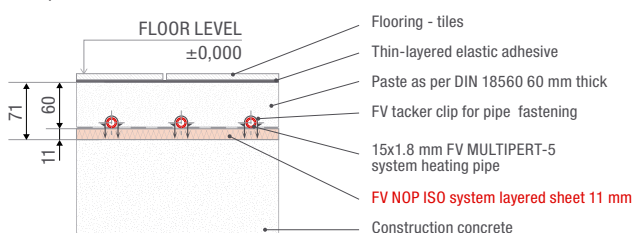

Figure 17: Recommended floor structure above cellar or occasionally heated rooms built terrain as per DIN EN 1264 norm recommendation, insulation heat resistance R = 1,25 m²K/W

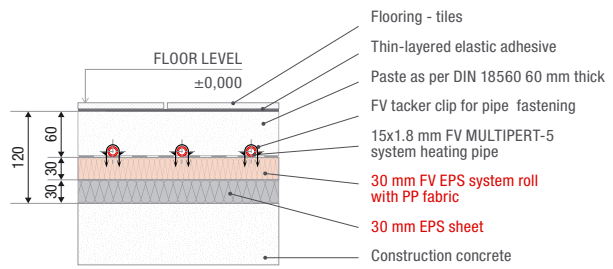
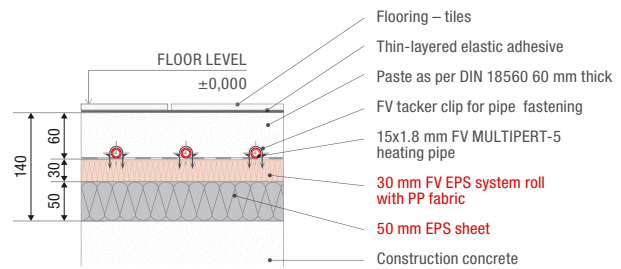

Figure 18: Recommended floor structure above outer area as per DIN EN 1264 norm recommendation, insulation heat resistance R = 2,00 m²K/W



4. FV THERM FLOOR HEATING DISTRIBUTOR

Regarding the regulation technical possibilities, the separate heating circuit should be added to each room. The room is divided into several heating circuits if the room is larger than one circuit can cover. The circuits larger than 120 m are not allowed. Multiple heating circuits can form one dilatation unit.

Needed heating circuits distributor emerge from the number of installed heating circuits. Recommended maximum system pressure lost (including the distributor and connecting screws) is 250 mbar.

The distributor is designed so that it can be installed on the wall or the distributor cabinet. The maximal circuits number connected to one distributor is 12.

Figure 19: FV THERM manifold with flowmeters



The connecting pipes from the source to the source with 1" AG connection is optional from left or right.

Figure 20: Supply and reverse connection from the side - horizontally

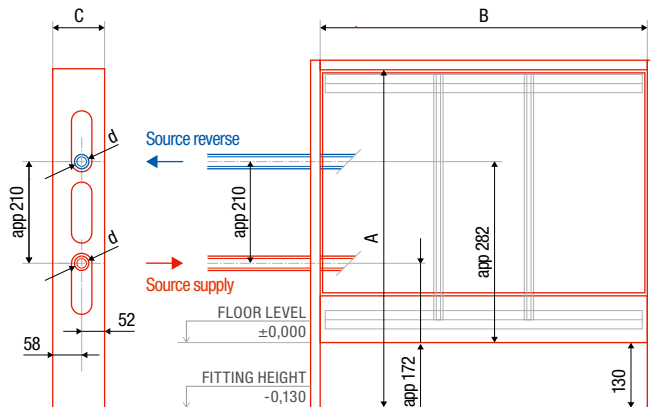

5. TIGHTNESS CONTROL

The device needs to be filled professionally and water-resistance checked after finishing installation. Norm VDI 2035 has to be met (the damage prevention in heating systems with hot water).

All intake and reverse valves are connected to the heating circuit distributor. A hose is connected to the water source. A hose ending in an outlet or outside the house is connected to a reverse arm. After the intake valve is opened, supply distributor is air bled. Afterwards, the first supply intake valve and the first reverse arm is opened.

When the heating circuit is filled with water so that no air is coming out of it, the first heating circuit is closed. The steps are analogous for other heating circuits. Filling and outlet armatures are closed when the filling and air bled process is completed. All intake and reverse valves are opened afterwards. The water-filled system undergoes a pressure testing as per ČSN EN 1264 norm requirements. The pressure testing is done by water because of the pipes damage prevention. The testing pressure is twice the amount of the operating pressure but minimal of 6 bar (as per ČSN EN 1264-4). The testing pressure is restored after two hours. Possible pressure decrease happens due to the pipes dilatation. The tes-

ting takes 12 hours. The pressure testing is successful if no water leaks from the pipes, joints and connection and the testing pressure does not decrease more than 0.1 bar per hour. A report about the pressure testing is made and inserted to the construction documentation.

The connecting system globe faucets are closed during the pressure testing to protect the heating devices and safety devices.

6. HYDRAULIC SETTING

Individual heating circuits setting is done when the tightening control is finished and before putting the device into operation (as per DIN EN 1264/EnEV). Individual heating circuits setting figures are stated in the project materials and set then on the supply arm flow indicators.

7. PASTE PRODUCTION AND PUTTING UNDERFLOOR HEATING INTO OPERATION

Pouring the underfloor heating pipes is realized after successful pressure testing is done. The pouring is done using the water-filled pipes and the operating pressure. Paste production meets DIN 1055 requirements.

Cement topping

FV plastificator is added to the cement topping for a better pipe covering, leaking concrete around the entire pipe, better heat permeability and against damages formed because of the effect of air bleeding additives containing calcium or softeners added to the topping.

The calcic sulphate and cement toppings are heated before the flooring layout. Function heating can be carried out no sooner than 21 days after using the cement toppings and 7 days using the calcic sulphate toppings.

Cement topping plastificator dosage:

$$M_s = 6,0 \cdot A_p \cdot t_l. \text{ [kg]}$$

where: A_p = underfloor heating floor area [m²]

t_l = planned paste thickness [m]

M_s = amount of FV plastificator for concrete [kg]

The theoretical usage of FV plastificator using 45 mm thick sheet over the pipe:

- For 1 m² of concrete topping = 0,39 kg
- For 1 m³ of concrete topping = 6,0 kg

DRY SYSTEM ASSEMBLY INSTRUCTIONS

Floor heating dry systems are advantageously used when renovating buildings, apartments and historic monuments, everywhere wet floor heating installation cannot be used. Due to a lower heating power output, compared to other types of installation, the dry system is particularly suitable for low-energy, prefabricated buildings and attics. Floors installed in a dry manner can work with a higher heating water temperature. The temperature of the intake water ranges between 40 and 70 °C. The temperature of the intake heating water must be adjusted to the resistance of all the components that come into contact with the heating water temperature. When it comes to a dry installation, the above mentioned stipulation particularly applies to the resistance of gypsum-fiber panels, which amounts to a maximum of 40 to 45 °C. The limiting characteristic of the gypsum boards has to be considered when preparing individual projects. This method is conveniently used for applications, for which a lower specific calorific power of up to 50 W/m² is sufficient, for example, additional heating surface or tempering, or for renovation applications, for which a low structural floor height is required.

Dry system advantages:

- Possibility to install the system even on structures with a limited load-bearing capacity (attics, ceilings with a low load-bearing capacity or vault ceilings)
- Can be used for renovations
- The structural height of the dry system structure is 50 mm
- Lower thermal inertia compared to a wet installation on concrete panels
- Possibility to start heating immediately after installation

FLOOR HEATING INSTALLATION INSTRUCTIONS - FV MULTIPERT-5 diameter 14 x 1,8 mm



FV MULTIPERT-5

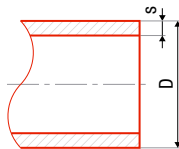

Icon	Icon	Icon	Icon	Icon	#	D [mm]	s [mm]
					AA120014200	14	1,8
					AA120014300	14	1,8

Permanent operation temperature:	+ 70 °C
Max. short-term thermal load:	+90 °C (max. 2 years)
Operation pressure:	4 bar
Complies with all the installation requirements pursuant to standard ISO 10508 for class 4+5	
Minimal bend radius	5xd (d= outer diameter)
Installation temperature:	from -5 °C to + 30 °C
Color:	red

5-layer, highly flexible system pipe made of PE-RT with an increased thermal resistance pursuant to EN ISO 22391, with an oxygen barrier pursuant to DIN 4726, and with an improved protection against mechanical damages incurred during transportation and handling at the construction site. Supplied lengths of 200 m and 300 m, rolled and taped in cardboard packages. Oxygen permeability at the temperature of 40 °C is way below the limit specified in DIN 4726. The EVOH barrier layer is inseparably attached to the main pipe using the HP method.

DRY SYSTEM STRUCTURE

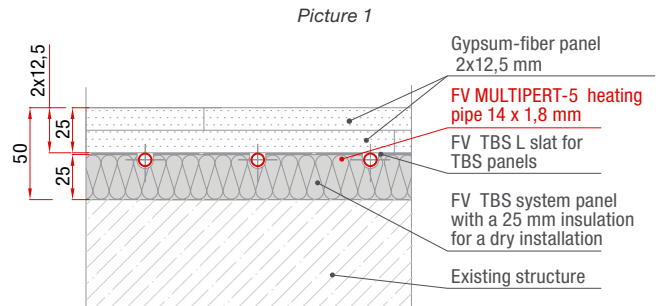

The total structural height of the dry system is 50 mm – see Picture 1. The heating pipes are installed in a meander manner – see Picture 2. The intake pipes are initially installed along the coldest wall. The basic span of the installed dry system pipes is 125 mm – see Picture 3. The span can be changed to 250 mm upon modifying the grooves at the curve.

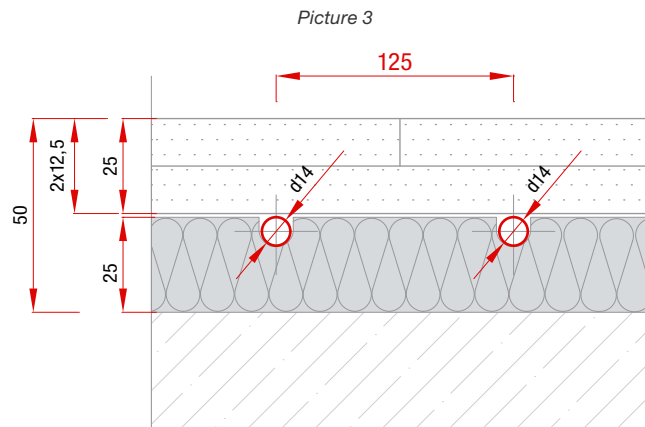
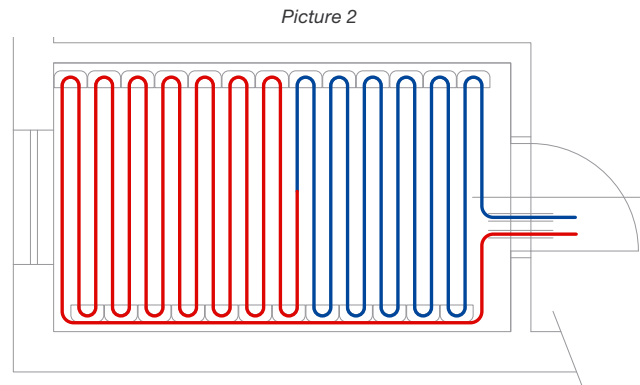

DRY SYSTEM COMPONENTS

FV TBS system panel with a 25-mm insulation for a dry installation

The base of the installation is formed by a polyester panel with milled grooves for mounting aluminum slats and slat arcs – see Pictures 4, 5 and 6. Aluminum slats are mounted in the grooves in the polyester panels. They increase the floor load bearing capacity and ensure an even heat distribution. The grooves are milled at 125 mm.

Picture 4: FV TBS system panel with a 25 mm insulation for a dry installation

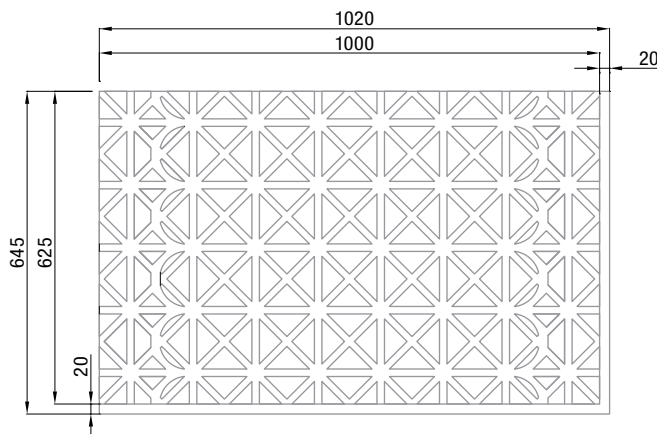

FV TBS system panel with a 25 mm insulation for dry installation	
Code	AA903001025
For diameter D	14 mm
typ wedlug DIN 4108-10	EPS 200
Acoustic insulation	dB
Thermal resistance	$R = 0,314 \text{ m}^2\text{K/W}$
Thermal conductivity	$\Lambda = 0,035 \text{ W/m.k}$
Maximal surface load	6 kN/m ²
Minimal installation span	125 mm
Minimal span for diagonal installation	125 mm
Panel (roll) dimensions	1020 x 645 x 25 mm
Surface color	White
Overall height	25 mm
Box (roll) dimensions	1030 x 655 x 540 mm
Box (roll) volume	364,31 dm ³
Panel volume	17,35 dm ³
Box (roll) weight	10 kg
Panel weight	0,479 kg
Number of panels/box	21
Number of boxes/pallet	8
Usable pallet surface	105,04 m ²
Net panel/roll surface	0,625 m ²
Sell unit	Piece

FV TBS L slat for FV TBS panels

Metal slats increase the floor strength and allow for an even heat distribution. Metal slats have pre-punched separation lines, 10 cm long. This allows for shortening them as necessary without the need of any additional assembly tools.

Picture 5: FV TBS L slat for FV TBS panels
Material: Fe/Zn, thickness 5 mm

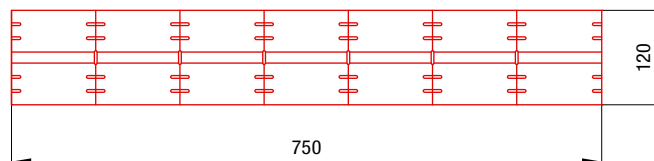

FV TBS C slat arc for FV TBS panels

This bend is fortified with a slat arc in order to ensure a safe bend for the 125 mm span. Min. bend radius without fortfection is $5 \times d = 5 \times 14 \text{ mm} = 70 \text{ mm}$

Picture 6: FV TBS C slat arc for FV TBS panels
Material: Fe/Zn, thickness 5 mm

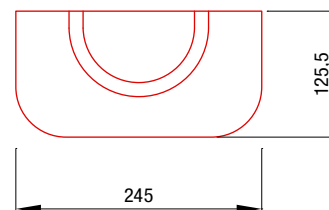

Once the heating circuit of the dry system is laid, the panels are covered by 2 gypsum-fiber panels, 2 x 12,5 mm (for example, Fermacell or Cetriss). Individual panels are installed in a way that they overlap the joints in both directions.

Final floor covering (tiles, vinyl, carpet, floating floor with a suitable perforated mat, etc.) is laid on the gypsum-fiber panels. Compared to the classic wet installation process, the structure of the dry system ensures that the floor becomes heated within a few minutes.

The average power output of the dry system is 50-60 W/m². A detailed layout plan of the panels and pipe assembly plan has to be prepared prior to installing the dry system. Max. length of the d 14 x 1,8 mm circuit is 60 m.

Material consumption per 1 m²:

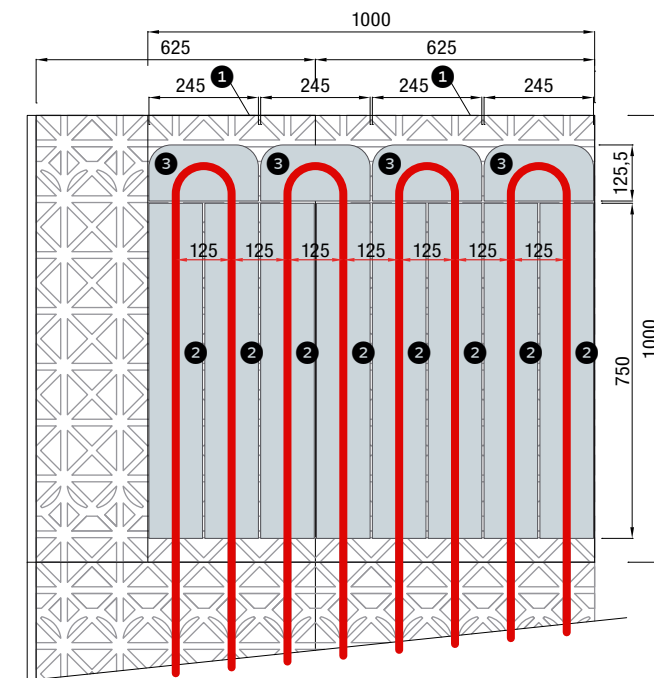

Picture 7: Material consumption per 1 m² for a dry installation

- 1. FV TBS system panel with a 25 mm insulation for a dry installation 2 pcs
- 2. FV TBS L slat for FV TBS panels..... 8 pcs
- 3. FV TBS C slat arc for FV TBS panels * 4 pcs
(*see the comparison of the need of slat arcs)

The need of slat arcs depends on the shape of the given floor surface – see the comparison for an identical overall floor size of 7,5 m².

Var. A

Room size 3 m x 2,5 m = 7,5 m². Pipeline length 60 m. Needed FV TBS C slat arcs - 23 pieces.

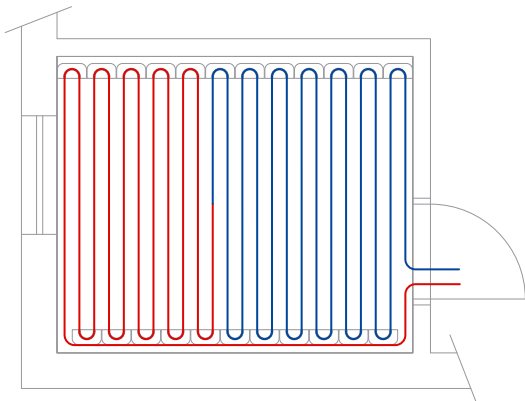

Var. B

Room size 1,5 m x 5 m = 7,5 m². Pipeline length 60 m. Needed FV TBS C slat arcs - 39 pieces.

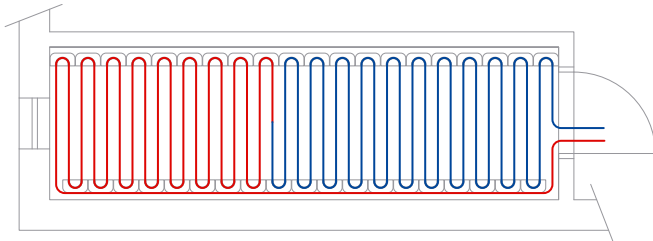

Var. C

Room size 1,5 m x 5 m = 7,5 m². Pipeline length 60 m. Needed FV TBS C slat arcs - 11 pieces.

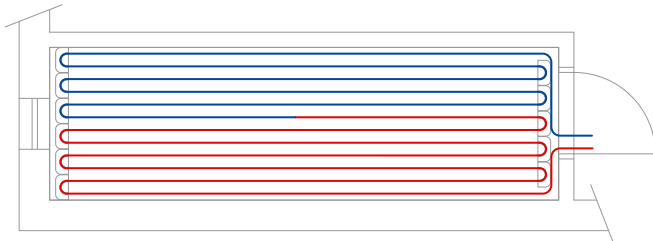

REGULATION

Floor heating can be regulated by changing the heating water temperature or by changing the flowrate in individual circuits. Heating water temperature can respond to the surrounding temperature using equithermal regulation at the source.

Flowrate regulation can be implemented manually, using flowrate meters installed along individual circuits. Yet another method consists of installing spatial thermostats that provide for the control of the thermal drives at the floor heating distributor. Their regulation can be used for changing the flowrate of a given heating medium in the floor heating circuits, thus decreasing or increasing the temperature of individual rooms.

BUILDING READINESS PRIOR TO THE DRY SYSTEM INSTALLATION

A correct installation of a dry floor heating system requires a project, i.e. at least the corresponding installation layout drawing and the standard building readiness and coordination with other professions at the construction site.

The implementation project has to consider not only a sufficient construction height for the actual floor heating system, but also the height of thermal insulation on the given building floors for preventing heat losses to the surroundings. Requirements for the height of thermal insulation differ based on the given building

character and the thermal impacts on every room. The requirements are different above a heated or unheated garage, and in other rooms where the base is formed by soil. The actual height of thermal insulation is decided by the given project. Thermal insulation has to comply with the requirements related to the given building assignment to individual energy classes.

The recommended height of thermal insulation on building ground floors above unheated spaces is:

- 30 cm for passive buildings
- 20 – 25 cm for low-energy buildings
- The standard recommended height is 10 – 16 cm

The recommended height of thermal insulation above heated spaces is 10 to 12 cm. This height also includes footstep insulation that is 2-4 cm thick.

System panels for the dry system are 25 mm thick. Any additional insulation pursuant to given project requirements is implemented using stabilized floor polystyrene (at least EPS 100) for preventing floor drops. It is recommended to implement the installation in two polystyrene layers laid transversely on top of each other. The entire structure is thus more stabilized, also preventing thermal bridges from the given building bedrock.

The following items have to be implemented prior to a floor heating system installation:

- Distribution water lines,
- Sewerage system lines,
- Wiring,
- Central vacuum cleaner, if applicable,
- Wall plasters.

The actual installation of the entire structure of thermal insulation and floor heating starts with a foundation slab. Horizontal hydro insulation has to be applied on the foundation slab.

When floor heating is installed on a floor that is in contact with soil, the radon load of the given building has to be checked and, if applicable, appropriate measures against radon have to be adopted in accordance with ČSN 730601, Building protection against radon in the bedrock, and ČSN 730602, Building protection against radon and gamma rays from construction materials. Should pipes be laid on a loadbearing base, the corresponding insulation has to be localized prior to the installation. The insulation under the pipes must not be damaged. The surface has to be even out again, thus making a flat surface for installing the insulation layer – at least a footstep insulation. Should the base layer contain residual moisture, rising of the moisture into the dry floor structure has to be prevented by a suitable structural modification (installation of a PE foil).

Individual dry installation for ducts should not be exposed to an increased air humidity before, during and after the construction process.

Upon the completion of the installation works, the devices should be professionally filled and its watertightness checked. The conditions of standard VDI 2035 (preventing damages in hot water heating systems) have to be complied with.

All intake and reverse valves have to be mounted to the heating circuit distributor. Connecting pipes from the source and to the source are implemented using 1" AG. The connection can be from the left or from the right. A hose has to be connected between the given water source and the intake. A hose that ends in a discharge outlet or outside of the building has to be connected to the reverse branch. The flow direction must be observed. Upon opening the intake valve, you need to air-bleed the incoming distributor pipe. Subsequently, you need to open the 1st incoming valve and the 1st reverse branch.

Should the heating circuit be completely filled with water, i.e. should no air be coming out at the free end any more, the 1st heating circuit has to be closed again. Proceed analogically with the other heating circuits. Upon the completion of the filling and air-bleeding process, the filling and discharging valves are closed again. Next, all intake and reverse valves have to be open. The system, now filled with water, has to be subjected to a pressure test pursuant to the requirements of standard ČSN EN 1264. The pressure test must be conducted using water in order to prevent any pipeline damage. The test pressure is twice the operation pressure, however, at least 6 bar (pursuant to ČSN EN 1264-4). The test pressure should be restored after two hours. Any pressure drop is usually the result of pipe dilatation. The test duration is 12 hours. The pressure test is considered successful if no water is leaking from any pipeline, joint or connection and if the test pressure does not drop by more than 0.1 bar per hour. Appropriate protocol has to be prepared on every pressure test. This protocol should be attached to the given construction documentation.

In order to protect the heating and safety devices, you need to make sure that the ball valves of the connecting system are closed during the pressure test.

DRY SYSTEM INSTALLATION PROCEDURE

- Install the distributor FV box under the plaster or on the plaster and mount the floor heating distributor in it.
- Fasten the border FV strip along the perimeter of all walls where the floor heating system will be installed.
- In order to prevent formation of mildew, install a permeable fortecton on the ceilings made of timber rafters.
- Make sure the base layer is flat. Occasional uneven spots of up to 1 cm should be evened out using suitable sealants. Smaller uneven spots on larger surfaces should be evened out using a floor levelling compound. Larger uneven spots should be evened out using suitable self-reinforcing dry matter, which should be then covered with drywall panels, at least 10 mm thick.
- Install thermal or footstep insulation of a thickness pursuant to the given forject.
- Install the FV THERM TBS dry system panels without any gaps, connected to the border slats of the panels.
- Implement grooves for connecting the circuit pipes to the distributor in front of the distributor. Separate individual pipes by implementing a layer of polystyrene.

- Mount FV TBS L slats and FV TBS C slat arcs into the grooves in the FV THERM TBS system panels pursuant to the given layout installation drawing.
- Install individual circuit pipes into the prepared grooves.
- Connect the intake pipes of individual circuits to the distributor.
- Rinse the heating circuits, fill them with a heat-transmitting medium and air-bleed them.

HYDRAULIC CONFIGURATION

Upon the completion of the tightness test and prior to putting the device into operation, you need to configure individual heating circuits (in accordance with DIN EN 1264/EnEV). Configuration values of individual heating circuits should be obtained from the corresponding forject documentation and set on the flowrate indicators of the intake branch. The applied hydraulic configuration thus contributes to the overall energy savings. In order to secure the implemented configurations, we recommend to secure and, if possible, to seal the safety covers on the flowrate indicators. You can thus quickly determine any configuration change. Pursuant to DIN 1264 and EnEV, configurations of individual heating circuits need to be set after the corresponding tightness tests.





SYSTEM COOLING PIPES

FV COOLING PE-RT 16x2 mm

System: **FV KLIMA**
 Material: PE-RT/EVOH/PE-RT
 Standard: EN ISO 22391, DIN 4726

For distribution of cooling and low-temperature heating. Pipe core from thermally resistant polyethylene is fortified from air diffusion by special chemical conditioning EVOH. Pipe surface is covered by polyethylene protective layer. Maximal safe temperature 60 °C and maximal working pressure 6 bar. Plug-in quick couplings and fittings connection.

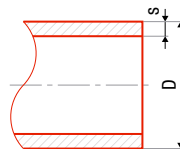

						#	D [mm]	s [mm]	l [m]
16 x 2,0	m	180	1	0,092	0,330	AA960130110	16	2,0	3

FV COOLING PB 8x1 mm

System: **FV KLIMA**
 Material: PB
 Standard: ČSN EN ISO 15876, DIN 4726

For registers line-up and forming of the active cooling and heating areas. Pipe core from very durable polybutylene is fortified from air diffusion by special chemical conditioning EVOH. Pipe surface is covered by polyethylene protective layer. Maximal safe temperature 60 °C and maximal working pressure 6 bar. Plug-in quick couplings and fittings connection.

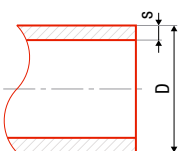

						#	D [mm]	s [mm]	l [m]
8 x 1,0	m	600		0,022	0,200	AA960138120	8	1,0	600

SYSTEM UNITS

FV cooling matting CoolFLEX

System: **FV KLIMA**
 Material: PB, AL-foil, PE
 Standard: -

High quality pipe from polybutylene FV COOLING PB 8x1 fused in aluminium foil, which equally delivers first class heat in whole cooling area. It is made in several variants: full matting for metal soffits (cassettes) and for plasterboard soffits, perforated mattings for acoustic metal soffits. Maximal safe temperature is 50 °C and maximal working pressure is 6 bar.(cassettes) and plasterboard.



						#	design	width [mm]	length [cm]	thickness [mm]	weight without water [kg/m ²]	weight with water [kg/m ²]
500 - 4000 mm	m ²	40		1,03	13,00	AA96071BCCC	perforated cassette	B*	CCC**	8,5	1,03	1,73
500 - 4000 mm	m ²	40		1,03	13,00	AA96072BCCC	full cassette	B*	CCC**	8,5	1,03	1,73
500 - 4000 mm	m ²	40		1,03	13,00	AA96073BCCC	full SDK	B*	CCC**	8,5	1,03	1,73
500 - 4000 mm	m ²	40		1,03	13,00	AA96074BCCC	perforated SDK	B*	CCC**	8,5	1,03	1,73

Note: **B*** width (1 - 180; 2 - 260; 3 - 340; 4 - 420; 5 - 500; 6 - 580; 7 - 660; 0 - 490 for plasterboard soffits),
CCC** length in cm

FV cooling plasterboard panel CoolPLATE

System: **FV KLIMA**
 Material: Plasterboard, polybutylene
 Standard: -

Pipes FV COOLING PB 8 x 1 are placed in milled grooves of antifire plasterboard having thickness 12,5 mm at a pitch 40 mm. Panels contain feeds long 1,2 m and those are connected to central distribution with use of plug-in fittings system. Maximal safe temperature is 45°. Maximal working pressure is 4 bar.



						#	width [mm]	length [mm]	thickness [mm]	1 pcs = area [m ²]
625 x 1000 mm	pcs	1		6,80	8,75	AA960130310	625	1000	12,5	0,625
625 x 2000 mm	pcs	1		13,50	17,50	AA960130320	625	2000	12,5	1,25
1250 x 1000 mm	pcs	1		13,50	17,50	AA960130330	1250	1000	12,5	1,25
1250 x 2000 mm	pcs	1		27,00	35,00	AA960130340	1250	2000	12,5	2,50

Plasterboard Thermalpanel FV KLIMA dpt. 10 mm

System: **FV KLIMA**
 Material: Gypsum with graphite
 Standard: -

Special plasterboard panel with addition of graphite and increased thermal conductivity. Fire reaction according to EN 13501-1: A2-s1, d0 (B).

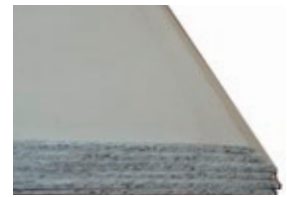

						#	surface [mm]	thickness [mm]	thermal conductivity [W/(m.K)]
1250 x 2000 mm	pcs	1		10	10	AA960130418	2,5	10	0,45

MANIFOLDS

Plastic segment manifold FV PUSH 16, 0,6-2,4 l/min

System: **FV KLIMA**
 Material: Polyamide PA6,6 30 % glass fibres
 Standard: -

Plastic segment manifold is equipped on the return point with visual adjustable flow meters 0,6-2,4 l/min. Both manifold bodies are equipped with loading and emptying valve, deaerating valve and holder. Maximal working temperature 70 °C. Manifold connection is 6/4" external screw. Circuit connection is made with use of plug-in fittings system for pipes d16 x 2 mm.



						#	number of circuits	width B [mm]
	pcs	1	1	1,4	5,730	AA960116231	1	138
	pcs	1	1	1,9	5,730	AA960116232	2	192
	pcs	1	1	2,3	5,730	AA960116233	3	247
	pcs	1	1	2,8	5,730	AA960116234	4	302
	pcs	1	1	3,3	5,730	AA960116235	5	358
	pcs	1	1	3,7	8,378	AA960116236	6	414
	pcs	1	1	4,2	8,378	AA960116237	7	469
	pcs	1	1	4,7	8,378	AA960116238	8	524
	pcs	1	1	5,2	11,026	AA960116239	9	580
	pcs	1	1	5,6	11,026	AA960116240	10	635
	pcs	1	1	6,1	11,026	AA960116241	11	691
	pcs	1	1	6,6	13,675	AA960116242	12	746
	pcs	1	1	7,0	13,675	AA960116243	13	801
	pcs	1	1	7,5	13,675	AA960116244	14	856
	pcs	1	1	8,0	15,280	AA960116245	15	911
	pcs	1	1	8,5	16,243	AA960116246	16	966
	pcs	1	1	8,9	17,174	AA960116247	17	1021
	pcs	1	1	9,4	18,137	AA960116248	18	1076
	pcs	1	1	9,9	19,100	AA960116249	19	1131
	pcs	1	1	10,3	20,063	AA960116250	20	1186

Note: For direct connection of FV COOLING PB 8 x 1 mm is the plastic segment manifold FV PUSH 8, 0,6 - 2,4 l/min available. The codes for order are from AA960116251 for a single-circuit manifold to AA960116260 for 20-circuit manifold.

Plastic segment manifold FV PUSH 16, 1-4 l/min

System: **FV KLIMA**
 Material: Polyamide PA6,6 30 % glass fibres
 Standard: -

Plastic segment manifold is equipped on the return point with visual adjustable flow meters 1-4 l/min. Both manifold bodies are equipped with loading and emptying valve, deaerating valve and holder. Maximal working temperature 70 °C. Manifold connection is 6/4" external screw. Circuit connection is made with use of plug-in fittings system for pipes d16 x 2 mm.



	pcs	1	1	1,4	5,73	#	number of circuits	width B [mm]
	pcs	1	1	1,9	5,73	AA960116331	1	138
	pcs	1	1	2,3	5,73	AA960116332	2	192
	pcs	1	1	2,8	5,73	AA960116333	3	247
	pcs	1	1	3,3	5,73	AA960116334	4	302
	pcs	1	1	3,7	8,38	AA960116335	5	358
	pcs	1	1	4,2	8,38	AA960116336	6	414
	pcs	1	1	4,7	8,38	AA960116337	7	469
	pcs	1	1	5,2	11,03	AA960116338	8	524
	pcs	1	1	5,6	11,03	AA960116339	9	580
	pcs	1	1	6,1	11,03	AA960116340	10	635
	pcs	1	1	6,6	13,67	AA960116341	11	691
	pcs	1	1	7,0	13,67	AA960116342	12	746
	pcs	1	1	7,5	13,67	AA960116343	13	801
	pcs	1	1	8,0	15,28	AA960116344	14	856
	pcs	1	1	8,5	16,24	AA960116345	15	911
	pcs	1	1	8,9	17,17	AA960116346	16	966
	pcs	1	1	9,4	18,14	AA960116347	17	1021
	pcs	1	1	9,9	19,10	AA960116348	18	1076
	pcs	1	1	10,3	20,06	AA960116349	19	1131
	pcs	1	1	10,3	20,06	AA960116350	20	1186

Plastic segment manifold FV PUSH 16, 2-8 l/min

System: **FV KLIMA**
 Material: Polyamide PA6,6 30 % glass fibres
 Standard: -

Plastic segment manifold is equipped on the return point with visual adjustable flow meters 2-8 l/min. Both manifold bodies are equipped with loading and emptying valve, deaerating valve and holder. Maximal working temperature 70 °C. Manifold connection is 6/4" external screw. Circuit connection is made with use of plug-in fittings system for pipes d16 x 2 mm.



	pcs	1	1	1,4	5,73	#	number of circuits	width B [mm]
	pcs	1	1	1,9	5,73	AA960116431	1	138
	pcs	1	1	2,3	5,73	AA960116432	2	192
	pcs	1	1	2,8	5,73	AA960116433	3	247
	pcs	1	1	3,3	5,73	AA960116434	4	302
	pcs	1	1	3,7	8,38	AA960116435	5	358
	pcs	1	1	4,2	8,38	AA960116436	6	414
	pcs	1	1	4,7	8,38	AA960116437	7	469
	pcs	1	1	5,2	11,03	AA960116438	8	524
	pcs	1	1	5,6	11,03	AA960116439	9	580
	pcs	1	1	6,1	11,03	AA960116440	10	635
	pcs	1	1	6,6	13,67	AA960116441	11	691
	pcs	1	1	7,0	13,67	AA960116442	12	746
	pcs	1	1	7,5	13,67	AA960116443	13	801
	pcs	1	1	8,0	15,28	AA960116444	14	856
	pcs	1	1	8,5	16,24	AA960116445	15	911
	pcs	1	1	8,9	17,17	AA960116446	16	966
	pcs	1	1	9,4	18,14	AA960116447	17	1021
	pcs	1	1	9,9	19,10	AA960116448	18	1076
	pcs	1	1	10,3	20,06	AA960116449	19	1131
	pcs	1	1	10,3	20,06	AA960116450	20	1186

FITTINGS AND ACCESORIES

FV spherical valve for dividers 1"-6/4"

System: **FV KLIMA**

Material: brass

Standard: -

Brassy sperical valve, for dividers FV with outlet nut and sealing.



						#	construction length [mm]	G	union nut G
	pcs	2	1	0,3	0,59	AA960117110	46	vnitřní 1/4"	6/4"

FV T - transitional quick coupling

System: **FV KLIMA**

Material: PPT

Standard: -

It is used for quick plug-in connection of pipes FV COOLING PE-RT 16 x 2 mm and FV COOLING PB 8 x 1 mm. Relieving cases are part of fittings packages.



illustrative photo

						#	supply diameter [mm]	pipe circuit [mm]
16 - 8 - 8 - 16	pcs	10	1	0,066	0,180	AA960134110	16	8 - 8
16 - 8 - 8	pcs	10	1	0,050	0,180	AA960134120	16	8 - 8
16 - 8 - 16	pcs	10	1	0,055	0,180	AA960134130	16	8

FV direct quick coupling

System: **FV KLIMA**

Material: PPT

Standard: -

It is used for quick plug-in connection of FV COOLING PIPES 16 x 2 mm or 8 x 1 mm. Relieving cases are part of fittings packages.



						#	pipe diameter 1 [mm]	pipe diameter 2 [mm]
8 - 8	pcs	10		0,015	0,05	AA960134210	8	8
16 - 16	pcs	10		0,038	0,12	AA960134220	16	16

FV angular tube - quick coupling

System: **FV KLIMA**

Material: PPT

Standard: -

It is used for quick plug-in connection of pipes FV COOLING PE-RT 16 x 2 or 8 x 1 mm. Relieving cases are part of fittings packages.



						#	supply diameter [mm]	supply diameter [mm]
8 - 8	pcs	10		0,066	0,050	AA960134310	8	8
16 - 16	pcs	10		0,045	0,120	AA960134320	16	16

FV transition

System: **FV KLIMA**

Material: brass

Standard: -

It is used for connection of pipes FV COOLING 16 x 2 mm a 8 x 1 mm to external screw 1/2" a 1/4". Relieving case is part of package.



						#	pipe diameter [mm]	G
16 - 1/2"	pcs	10		0,045	0,04	AA960134510	16	1/2"
8 - 1/4"	pcs	10		0,034	0,04	AA960134511	8	1/4"
8 - 1/2"	pcs	10		0,014	0,03	AA960134512	8	1/2"

FV blinder (sealing) unit

System: **FV KLIMA**

Material: PP

Standard: -

Plug is used for blinding (sealing) of plug-in fittings.



Q ₁₁₁	⊕	☐	☐	⊞	dm	#	pipe diameter [mm]		
8	pcs	10		0,001	0,01	AA960134610	8		
16	pcs	10		0,008	0,02	AA960134620	16		

FV relieving case

System: **FV KLIMA**

Material: brass

Standard: -

It is for relieving of pipe in fitting to provide safe connection. Normally it is part of fittings package, must be separately ordered with manifold FV PUSH and as accessories.



Q ₁₁₁	⊕	☐	☐	⊞	dm	#	pipe diameter [mm]	thickness of the wall [mm]	
8 x 1 mm	pcs	10	1	0,0008	0,004	AA960134710	8	1	
16 x 2 mm	pcs	20	1	0,004	0,06	AA960134720	16	2	

REGULATION

FV actuator NC-24V

System: **FV KLIMA**

Material: plastic

Standard: -

It provides regulation of the FV PUSH individual manifold valves.

Connection: outlet nut M30 x 1,5

Varianta: NC (closed when current-free)

Cover: IP65



Q ₁₁₁	⊕	☐	☐	⊞	dm	#	height [mm]	diameter [mm]	cable length [mm]
	pcs	1	1	0,146	0,36	AA960139120	70	45	1000

FV KLIMA manual areal thermostat

System: **FV KLIMA**

Material: plastic

Standard: -

Areal thermostat for regulation of heating and cooling systems in two-pipe and four-pipe application. It enables direct connection up to 5 condensation point receptor. Working status coloured indication, regulation range 5-30 °C, connection 24VAC, Ip40, input power 35 mA.



Q ₁₁₁	⊕	☐	☐	⊞	dm	#			
	pcs	1	1	0,11	0,33	AA960139315			

FV condensation point receptor

System: **FV KLIMA**
 Material: plastic, gilded copper
 Standard: -

it records eventual risk of condensation and informs areal thermostat or condensation point convertor. Cable length 10 m, placing on feed pipe from distributor, in contact with internal area of room.



						#			
	pcs	1	1	0,165	0,68	AA960139410			

FV condensation point receptor for plasterboard

System: **FV KLIMA**
 Material: plastic, gilded copper
 Standard: -

it records eventual risk of condensation and informs areal thermostat or condensation point convertor. It is equipped with buffering pipe for assembly to light soffit constructions. Cable length 10 m, pipe length 400 mm, placing on feed pipe from distributor, in contact with internal area of room.



						#			
	pcs	1	1	0,25	2,10	AA960139420			

FV condensation point convertor

System: **FV KLIMA**
 Material: plastic
 Standard: -

it serves as an convertor of the condensation point receptors and thermic regulation of the building within the areal cooling system applications. It detects status of the condensation point receptors and in case of the condensation risk it switches output potential-free relay contact. It enables parallel connection up to 5 condensation point receptors.

Working voltage: 24 VAC, IP20, current consumption 40mA.
 Potential-free switch contact: 6 (2) A/230VAC



						#			
	pcs	1	1	0,077	0,47	AA960139510			

FV bus UZR 24 - 4

System: **FV KLIMA**
 Material: plastic
 Standard: -

4 channel module of the zone regulation. It is basic construction element of the zone regulation. It forcesses directions from areal thermostats and controls individual heating circuits with use of actuators. It contains power supply, connection of actuator units and thermostats, statuses indicator and pumping device module.

Working voltage 24 VAC, gray colour



						#			
	pcs	1	1	0,224	1,44	AA960276441			

FV extending bus module URM 24 - 2

System: **FV KLIMA**
 Material: plastic
 Standard: -

2 channel extending module of the zone regulation UZR 24-4 for actuators having 24V.
 Working voltage 24 VAC, gray colour



						#			
	pcs	1	1	0,148	1,44	AA960276443			

ACCESSORIES

Clamping bar PENTA Ø14/15/16/17/18

System: **FV KLIMA**
 Material: PP
 Standard: -

for docking of ceiling cooling distribution from pipe 16 x 2 mm. Bar is consisted of more separable parts with unlimited length extension option.



QTY	PCS	QTY	QTY	WGT	DM	#	D [mm]	pitch [mm]	length [mm]
14-18 x 1,0 m	pcs	100	1	0,181	0,820	AA960112125	14 - 18	50	1000

Clamping bar R 25 for pipe 8x1

System: **FV KLIMA**
 Material: PP
 Standard: -

for fixation of cooling and heating register's.



QTY	PCS	QTY	QTY	WGT	DM	#	D [mm]	pitch [mm]	length [mm]
8 x 1 mm	pcs	200	1	0,068	0,280	AA960112127	8	25	800

Arc console for clamping bar R 25

System: **FV KLIMA**
 Material: PP
 Standard: -

for fixation of cooling and heating register's arcs with the clamping bar R 25.



QTY	PCS	QTY	QTY	WGT	DM	#	D [mm]		
14-18 x 1,0 m	pcs	100	1	0,008	0,110	AA960112128	8 x 1,0 mm		

FV silicone paste for sealing O-circlets

System: **FV KLIMA**
 Material: silikon
 Standard: -

It is deposited prior to plugging in of the connecting screwing to pipe or anywhere else, where are used sealing o-circlets. Greasing substance prevents eventual mechanic damage of sealing while mounting.



QTY	PCS	QTY	QTY	WGT	DM	#			
	pcs	1	1	0,075	0,20	AA960991120			

INSTALLATION INSTRUCTIONS FOR COOLING SYSTEM

1. APPLICATION OF THE SYSTEM

Ceiling cooling/heating FV KLIMA is made in several construction variations adapted to various ceiling constructions. New system CoolFLEX allows to be used for all types of radiating large-area systems for ceiling, wall, flooring:

1.1. SYSTEM CoolFLEX FOR METAL SOFFITS (FULL OR ACOUSTIC)

System consists of thin cooling registers CoolFLEX, which are placed in metal soffit cassettes. Registers CoolFLEX are tailored according to forject specifications. Cooling performance is 75 W/m².

Assembly

- Prepare metal carrying construction for ceiling metal soffits.
- Install central distribution from pipe FV COOLING PE-RT 16 x 2 mm and quick couplings into area of the soffit.
- CoolFLEX registers are placed into the metal cassettes and connect to central distribution by use of quick couplings.
- Run test of the sealing and test of regulation functionality.

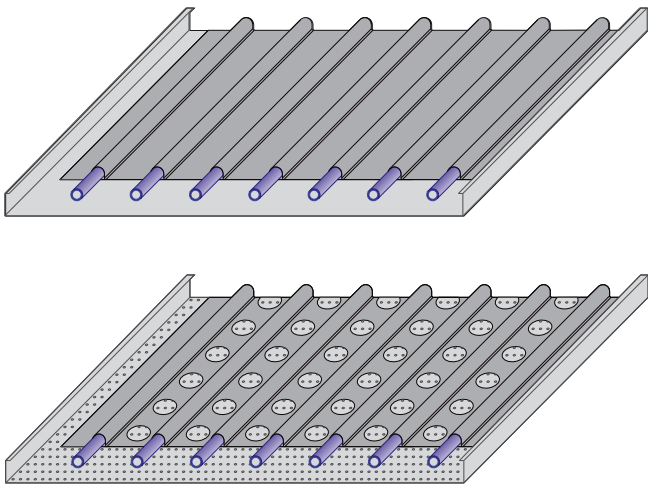

1.2. SYSTEM CoolFLEX FOR PLASTERBOARD CEILINGS (FULL OR ACOUSTIC)

System consists of thin cooling registers CoolFLEX, which are placed on plasterboard panels and it offers simple and safe mounting. For providing the maximal performance there are used plasterboard panels with increased thermal conductivity (contains graphite). Docking system uses standard metal construction designed for plasterboard ceilings, using CD and UD metal forfiles. Registers CoolFLEX are tailored according to forject specification. Cooling performance is 70 W/m².

Assembly

- prepare metal carrying construction for PBD ceilings. Spacing of mounting sections is 500 mm.
- install central distributor from pipe COOLING PE-RT 16 x 2 mm into area of the soffit
- stick registers CoolFLEX to mounting sections and connect those to central distribution by use of quickcouplings
- run test of the sealing and test of regulation functionality
- close ceiling with plasterboard panels with thermal conductivity according to forject documentation.

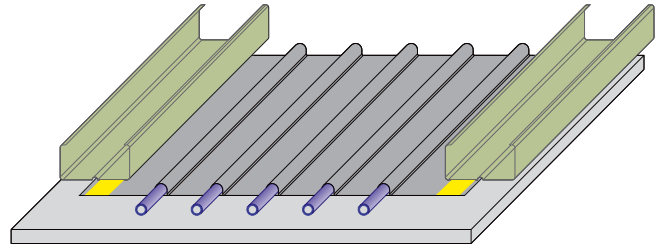

1.3. ACTIVE PLASTERBOARD PANELS CoolPLATE

Cooling pipes are placed in plasterboard grooves. Individual active cooling panels CoolPLATE are tailored according to forject specification. Active plasterboard panels are installed to standard metal construction designed for lowered ceilings, using CD and UD forfiles. The cooling capacity is up to 60 W/m².

Assembly

- prepare metal carrying construction for PBD ceilings. Spacing of mounting sections is 333 mm.
- install central distributor from pipe COOLING PE-RT 16 x 2 mm into area of the soffit
- fasten active plasterboard panels CoolPLATE to mounting sections and connect those to central distribution by use of quickcouplings
- run test of the sealing and test of regulation functionality.

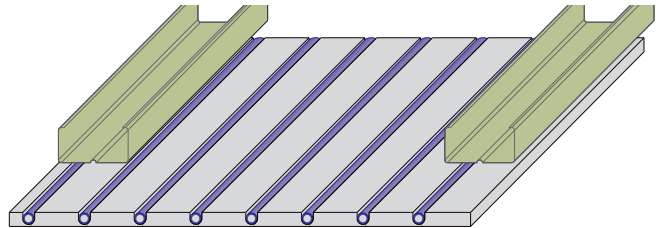

1.4. UNDER-PLASTERING SYSTEM CoolGRID

Cooling pipes CoolGRID are placed in ceiling plastering. Those are used in combination with core plastering or with hard plaster in the thickness of 10 to 20 mm. Cooling registers CoolGRID are created by placing pipes to bars directly during mounting. Cooling performance is 70 W/m² in dependance of pitch and used plastering substance.

System CoolGRID assembly forcedure

- Ceiling must comply to base flatness conditions pursuant to ČSN EN 13914-2 (5 mm/2 m). Base ceiling concrete must be hard and dry, it is necessary to remove any dirt and flatten jogs.
- In the rooms where the ceiling cooling system is to be installed there should be forced base in line with technological regulations of plastering substance supplier.
- Install central distribution from pipe FV COOLING PE-RT 16 x 2 mm.
- Place docking grooves for pipe Ø 8 x 1 mm in required spacing to the area of ceiling. The best way to place grooves is to fasten those with coaks Ø 5 mm or other appropriate way.
- Place pipe COOLING PB 8 x 1 mm to the grooves and connect that to central distribution with use of quick couplings.
- Run test of the sealing and test of regulation functionality.

Plastering the system CoolGRID

- For plastering of the ceiling we recommend to use appropriate hard plaster or core plaster substance with thermal conductivity relevant to the forject. Application is to be regulated by substance suppliers notes.
- Minimal thickness of the plastering is 20 mm.
- Sizes of dilatation units are to be regulated by used plastering substance notes.
- Within plastering there must be suitable pressure it the system and it is necessary to perform checkouts of the system pressure.

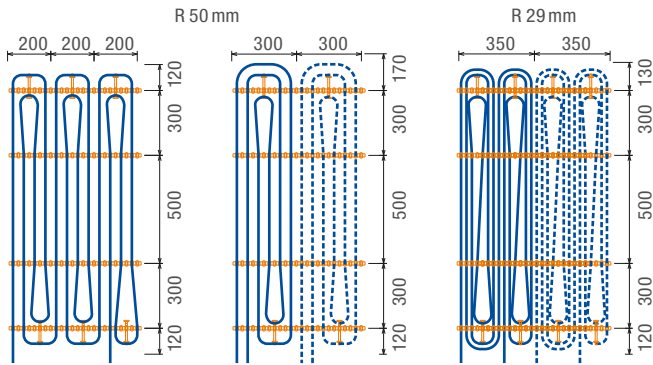

2. BASIC RECOMMENDATIONS FOR SYSTEM CONCEPT

- to prevent condensate appearance, ceiling must be laid out in such a way, so feed water temperature would be always above condensate point temperature
- required height of the soffit construction within plasterboard and compartment ceilings is 6 – 20 cm
- in case of the system cooling plastering, it is recommended total thickness of plastering 2 cm
- optimal length of circuit with pipe $\varnothing 8 \times 1$ mm is 20 – 40 m
- optimal active cooling area size for one sub-circuit of distributing pipe $\varnothing 16 \times 2$ mm is 10 – 15 m²
- up to 15 cooling sub-circuits can be connected per one manifold
- each sub-circuit must be equipped with regulating valve with actuator
- condensation point receptor must be placed in each room on the feed duct
- it is recommended to provide air ventilation with modified air
- if using heating system it is recommended to use insulant material of thickness 3 – 5 cm above cooling registers.
- if using ceiling system heating is temperature of heating water limited to 45 °C.
- system can be fed by drinkable water without mechanical dirt
- dilatation of cooling/heating ceilings must be designed and applied according to technical layouts and recommendations of plastering substances and plasterboard panels producers.

3. COMMENCEMENT

After assembly and checkout of whole system there is feeding of circuits with clear water according to following procedure:

- all circuits on manifold are closed with use of manual caps and flow meters rotation
- pressure water is supplied to feeding manifold valve and hosepipe is placed to emptying collector valve and conducted away to sewer
- first circuit is opened, water is allowed to flow and once clear air-free stream of water flows the circuit is closed by both valve and flow meter
- another circuit is opened then and so step-by-step is fed the rest of circuits
- afterwards both distributor units are deaerated having closed valves and flow meters
- all circuits are opened and sealing test is run according to following procedure
- system is pressured to 6 bar, pressure is maintained during 10 minutes and then quickly released
- system is pressured to 2 bar, pressure is maintained during 10 minutes and then quickly released
- system is pressured to 4 bar. Pressure mustn't be decreased under 3,4 bar during 30 minutes and during another 2 hours under 3,2 bar
- during test there mustn't be leakages, test records shall be done
- circuit pumping device is launched and rejected flow in all sub-circuits is set by rotating of flow meters
- functional test of regulation is done and the system is prepared for use

4. ASSEMBLY PROCESS

Fittings assembly is made according to following working procedure. Along whole time of handling with fittings it is necessary to take precise care about cleanliness of the fitting and pipe as well, predominantly of their sealing parts.



Pipe is cut by pliers vertically to the duct axis. To prevent pipe flattening it is recommended to rotate pipe in the pliers.



Internal edge of pipe is slightly splayed by manual reamer to depth approx. 1 mm.



Reinforcing sleeve is fully inserted into pipe.



Ending of pipe is covered by silicone paste in range of 15 mm.



Fitting is fully slip over pipe. Pipe 16 is slip over for 27 mm, pipe 8 for 20 mm. Marks printed on the pipe are designed for orientation.



After the assembly it is possible to rotate contact and after pressing locking circle pipe can be put out. If mounting again pipe needs to be oiled and checked if there is no damage.



MANIFOLD SHAFTS

NEW BRADO

Waterproof shaft with integrated manifolds to distribute and collect anti-freeze liquid transferring heat between vertical or horizontal collectors and a heat pump. Can be connected to the piping by means of electrofusion fittings or mechanical couplers for HDPE.

- Inlet piping d40, outlet piping d50 and d63
- Number of output circuits 2 to 10
- Option to attach rotameters
- Step-on PP/GF cover as standard

* xx substitute in Cat. No. with the diameter of transition pipe and yy with diameter of collector pipes



type	number of circuits	# with rotameters	# with shut off valves	Ø of collector pipes	Ø outlet piping	Ø outer [mm]	height [mm]	Ø inner [mm]	weight [kg]
NEW BRADO 2	2	AA72102xxyy	AA72202xxyy	40	50	738	803	650	21
NEW BRADO 3	3	AA72103xxyy	AA72203xxyy	40	50				23
NEW BRADO 4	4	AA72104xxyy	AA72204xxyy	40	63				25
NEW BRADO 5	5	AA72105xxyy	AA72205xxyy	40	63				27
NEW BRADO 6	6	AA72106xxyy	AA72206xxyy	40	63				29
NEW BRADO 7	7	AA72107xxyy	AA72207xxyy	40	63				31
NEW BRADO 8	8	AA72108xxyy	AA72108xxyy	40	63				33
NEW BRADO 9	9	AA72109xxyy	AA72209xxyy	40	63				35
NEW BRADO 10	10*	AA72110xxyy	AA72210xxyy	40	63				37

* Other diameters of collectors and outlet pipes on request.

ALTRA SCANDIC

Waterproof shaft with integrated manifolds to distribute and collect anti-freeze liquid transferring heat between vertical or horizontal collectors and a heat pump. Can be connected to the piping by means of electrofusion fittings or mechanical couplers for HDPE.

- Inlet piping d40, outlet piping d63
- Number of output circuits 6 to 18
- Suitable for larger flat collectors
- Option to attach rotameters

* xx substitute in Cat. No. with the diameter of transition pipe and yy with diameter of collector pipes



type	number of circuits	# with rotameters	# with shut off valves	Ø of collector pipes	Ø outlet piping	Ø outer [mm]	height [mm]	width [mm]	weight [kg]
ALTRA SCANDIC 6	6	AA72306xxyy	AA72406xxyy	40	63	896 - 900	1095	909 - 807	51
ALTRA SCANDIC 7	7	AA72307xxyy	AA72407xxyy	40	63				53
ALTRA SCANDIC 8	8	AA72308xxyy	AA72408xxyy	40	63				55
ALTRA SCANDIC 9	9	AA72309xxyy	AA72409xxyy	40	63				57
ALTRA SCANDIC10	10	AA72310xxyy	AA72410xxyy	40	63				59
ALTRA SCANDIC 11	11	AA72311xxyy	AA72411xxyy	40	63				61
ALTRA SCANDIC 12	12	AA72312xxyy	AA72412xxyy	40	63				63
ALTRA SCANDIC 13	13	AA72313xxyy	AA72413xxyy	40	63				65
ALTRA SCANDIC 14	14	AA72314xxyy	AA72414xxyy	40	63				67
ALTRA SCANDIC 15	15	AA72315xxyy	AA72415xxyy	40	63				69
ALTRA SCANDIC 16	16	AA723146xxyy	AA72416xxyy	40	63				71
ALTRA SCANDIC 17	17	AA72317xxyy	AA72417xxyy	40	63				73
ALTRA SCANDIC 18	18	AA72318xxyy	AA72418xxyy	40	63				75

* Other diameters of collectors and outlet pipes on request.

SPIDER

Waterproof shaft with integrated manifolds to distribute and collect anti-freeze liquid transferring heat between vertical or horizontal collectors and a heat pump. Can be connected to the piping by means of electrofusion fittings or mechanical couplers for HDPE.

- Inlet piping d40, outlet piping d75 - d110
- Number of output circuits 15 to 30
- Step-on PP/GF cover as standard
- Option to attach rotameters

* xx substitute in Cat. No. with the diameter of transition pipe and yy with diameter of collector pipes



type	number of circuits	# with rotameters	# w/o rotameters	Ø of collector pipes	Ø outlet piping	Ø outer [mm]	length [mm]	weight [kg]
SPIDER 15	15	AA72715xxyy	AA72815xxyy	40	75	1000	1860	162
SPIDER 16	16	AA72716xxyy	AA72816xxyy	40	75			164
SPIDER 17	17	AA72717xxyy	AA72817xxyy	40	75			165
SPIDER 18	18	AA72718xxyy	AA72818xxyy	40	75			167
SPIDER 19	19	AA72719xxyy	AA72819xxyy	40	75			169
SPIDER 20	20	AA72720xxyy	AA72820xxyy	40	75			170
SPIDER 21	21	AA72721xxyy	AA72821xxyy	40	90			172
SPIDER 22	22	AA72722xxyy	AA72822xxyy	40	90			174
SPIDER 23	23	AA72723xxyy	AA72823xxyy	40	90			176
SPIDER 24	24	AA72724xxyy	AA72824xxyy	40	90			178
SPIDER 25	25	AA72725xxyy	AA72825xxyy	40	90			180
SPIDER 26	26	AA72726xxyy	AA72826xxyy	40	110			182
SPIDER 27	27	AA72727xxyy	AA72827xxyy	40	110			184
SPIDER 28	28	AA72728xxyy	AA72828xxyy	40	110			186
SPIDER 29	29	AA72729xxyy	AA72829xxyy	40	110			188
SPIDER 30	30	AA72730xxyy	AA72830xxyy	40	110			190

* Other diameters of collectors and outlet pipes on request.

GIGA

Waterproof shaft with integrated manifolds to distribute and collect anti-freeze liquid transferring heat between vertical or horizontal collectors and a heat pump. Can be connected to the piping by means of electrofusion fittings or mechanical couplers for HDPE.

- Inlet piping d40-d90, outlet piping d32 and d40
- Number of output circuits 2 to 6
- Step-on PP/GF cover as standard
- Option to attach rotameters

* xx substitute in Cat. No. with the diameter of transition pipe and yy with diameter of collector pipes



type	number of circuits	# with rotameters	# w/o rotameters	Ø of collector pipes	Ø outlet piping	height [mm]	length [mm]	width [mm]	weight [kg]
Giga 2	2	AA72502xxyy	AA72602xxyy	32 - 40	40 - 50 - 63 - 90	1530	1280	909	80
Giga 3	3	AA72503xxyy	AA72603xxyy	32 - 40	40 - 50 - 63 - 90				83
Giga 4	4	AA72504xxyy	AA72604xxyy	32 - 40	40 - 50 - 63 - 90				85
Giga 5*	5	AA72505xxyy	AA72605xxyy	32 - 40	40 - 50 - 63 - 90				88
Giga 6*	6	AA72506xxyy	AA72606xxyy	32 - 40	40 - 50 - 63 - 90				91

* 5 a 6 circles = 2 shafts connected to the cascade.
Other diameters of collectors and outlet pipes on request.

MANIFOLD BOXES

NOMO

Fully equipped wall case with manifolds to distribute and collect anti-freeze liquid transferring heat between vertical or horizontal collectors and a heat pump. Can be connected to the piping by means of electrofusion fittings or mechanical couplers for HDPE. The cabinet is sufficiently insulated to be placed outdoors.

- Inlet piping d50, outlet piping d32 and d40
- Number of output circuits 2 - 6
- Option to attach rotameters
- Placement outside a building

* xx substitute in Cat. No. with the diameter of transition pipe and yy with diameter of collector pipes



type	number of circuits	# with rotameters	# w/o rotameters	Ø of collector pipes	Ø outlet piping	height [mm]	length [mm]	width [mm]	weight [kg]
NOMO 2	2	AA73102xxyy	AA73202xxyy	25 - 32 - 40	40 - 50 - 63	790	800	320	23
NOMO 3	3	AA73103xxyy	AA73203xxyy	25 - 32 - 40	40 - 50 - 63				25
NOMO 4	4	AA73104xxyy	AA73204xxyy	25 - 32 - 40	40 - 50 - 63				26
NOMO 5	5	AA73105xxyy	AA73205xxyy	25 - 32 - 40	40 - 50 - 63				27
NOMO 6	6	AA73106xxyy	AA73206xxyy	25 - 32 - 40	40 - 50 - 63				28

REGA

Fully equipped wall case with manifolds to distribute and collect anti-freeze liquid transferring heat between vertical or horizontal collectors and a heat pump. Can be connected to the piping by means of electrofusion fittings or mechanical couplers for HDPE. The cabinet must be placed indoors.

- Inlet piping d50, outlet piping d32 and d40
- Number of output circuits 2 and 3
- Option to attach rotameters
- Quality polyurethane thermal insulation
- Placement inside a building

* xx substitute in Cat. No. with the diameter of transition pipe and yy with diameter of collector pipes



type	number of circuits	# with rotameters	# w/o rotameters	Ø of collector pipes	Ø outlet piping	height [mm]	length [mm]	width [mm]	weight [kg]
REGA 2	2	AA73302xxyy	AA73402xxyy	25 - 32 - 40	40 - 50 - 63	430	380	180	7
REGA 3	3	AA73303xxyy	AA73403xxyy	25 - 32 - 40	40 - 50 - 63				8

MANIFOLD PLEIN

REGO

Fully equipped wall manifolds to distribute and collect anti-freeze liquid transferring heat between vertical or horizontal collectors and a heat pump. Can be connected to the piping by means of electrofusion fittings or mechanical couplers for HDPE.

- Inlet piping d50, outlet piping d32 and d40
- Number of output circuits 2 - 12
- Option to attach rotameters
- Quality polyurethane thermal insulation
- Placement inside a building

* xx substitute in Cat. No. with the diameter of transition pipe and yy with diameter of collector pipes



type	number of circuits	# with rotameters	# w/o rotameters	Ø of collector pipes	Ø outlet piping	height [mm]	length [mm]	width [mm]	weight [kg]
REGO 2	2	AA73502xxyy	AA73602xxyy	25 - 32 - 40	40 - 50 - 63	430	480	265	13
REGO 3	3	AA73503xxyy	AA73603xxyy	25 - 32 - 40	40 - 50 - 63				14
REGO 4	4	AA73504xxyy	AA73604xxyy	25 - 32 - 40	40 - 50 - 63				15
REGO 5	5	AA73505xxyy	AA73605xxyy	25 - 32 - 40	40 - 50 - 63				16
REGO 6	6	AA73506xxyy	AA73606xxyy	25 - 32 - 40	40 - 50 - 63				17
REGO 7	7	AA73507xxyy	AA73607xxyy	25 - 32 - 40	40 - 50 - 63				18
REGO 8	8	AA73508xxyy	AA73608xxyy	25 - 32 - 40	40 - 50 - 63				19
REGO 9	9	AA73509xxyy	AA73609xxyy	25 - 32 - 40	40 - 50 - 63				20
REGO 10	10	AA73510xxyy	AA73610xxyy	25 - 32 - 40	40 - 50 - 63				21
REGO 11	11	AA73511xxyy	AA73611xxyy	25 - 32 - 40	40 - 50 - 63				22
REGO 12	12	AA73512xxyy	AA73612xxyy	25 - 32 - 40	40 - 50 - 63				23

ACCESSORIES TO DISTRIBUTOR WELLS

type	unit	package	#	Ø outer [mm]	Ø inner [mm]	height [mm]
ERGA extension for shafts NEW BRADO, ALTRA	pcs	1	AA750100001			500
GEO 500 extension for shafts GIGA	pcs	1	AA750100002			500
BAGELAN A seal for extension GEO 500	pcs	1	AA750200001			
BAGELAN B seal for extension ERGA	pcs	1	AA750200002			
Seal for extension	pcs	1	AA750200003			
Manhole PE cover 10 kN	pcs	1	AA751100010			
Manhole PE cover 10 kN with safety lock	pcs	1	AA751100011			
Manhole PE cover 10 kN with thermal insulation 200 mm	pcs	1	AA751100012			200
Seal for manhole cover	pcs	1	AA751200000			
Load relief concrete ring symmetrical	pcs	1	AA751100402	1440	670	200
Load relief concrete ring unsymmetrical	pcs	1	AA751100403	1440	670	200
Manhole cover cast iron class D 400 kN	pcs	1	AA751100400	820	680	115
Leakproof PE cover under cast iron or concrete manhole cover	pcs	1	AA751100401	670		

FITTINGS

Electrofusion socket SDR 11

For the system FV ENERGEO we deliver reliable electrofusion fittings Georg Fisher with integrated brackets to 63 mm diameter.

- They are equipped with barcode
- integrated holders



dimensions	unit	package	#	length [mm]		
25	pcs	1	AA760000025			
32	pcs	1	AA760000032			
40	pcs	1	AA760000040			
50	pcs	1	AA760000050			
63	pcs	1	AA760000063			
90	pcs	1	AA760000090			
110	pcs	1	AA760000110			

Electrofusion blinding SDR 11

For the system FV ENERGEO we deliver reliable electrofusion fittings Georg Fisher with integrated brackets to 63mm diameter.

- They are equipped with barcode
- integrated holders



dimensions	unit	package	#	length [mm]		
25	pcs	1	AA761000025			
32	pcs	1	AA761000032			
40	pcs	1	AA761000040			
50	pcs	1	AA761000050			
63	pcs	1	AA761000063			

Electrofusion reduction of SDR 11

For the system FV ENERGEO we deliver reliable electrofusion fittings Georg Fisher with integrated brackets to 63 mm diameter.

- They are equipped with barcode
- integrated holders



dimensions	unit	package	#	length [mm]		
40 - 32	pcs	1	AA762040032			
32 - 25	pcs	1	AA762032025			

Electrofusion bend 90° SDR 11

For the system FV ENERGEO we deliver reliable electrofusion fittings Georg Fisher with integrated brackets to 63 mm diameter.

- They are equipped with barcode
- integrated holders



dimensions	unit	package	#			
25	pcs	1	AA763000025			
32	pcs	1	AA763000032			
40	pcs	1	AA763000040			
50	pcs	1	AA763000050			
63	pcs	1	AA763000063			
90	pcs	1	AA763000090			
110	pcs	1	AA763000110			

Insert transition PE - brass female thread SDR 11

For the system FV ENERGEO we deliver reliable electrofusion fittings Georg Fisher with integrated brackets to 63 mm diameter.

- Easy assembly with electro-fittings by Georg Fischer.



dimensions	unit	package	#			
32 - 1"	pcs	1	AA764032010			
40 - 1 1/4"	pcs	1	AA764040054			
50 - 1 1/2"	pcs	1	AA764050064			
63 - 1"	pcs	1	AA764063010			
63 - 1 1/4"	pcs	1	AA764063054			
63 - 1 1/2"	pcs	1	AA764063064			
63 - 2"	pcs	1	AA764063020			

Insert transition PE - brass male thread SDR 11

For the system FV ENERGEO we deliver reliable electrofusion fittings Georg Fisher with integrated brackets to 63 mm diameter.

- Easy assembly with electro-fittings by Georg Fischer.



dimensions	unit	package	#			
25 - 3/4"	pcs	1	AA765025034			
32 - 1"	pcs	1	AA765032010			
32 - 1 1/4"	pcs	1	AA765032054			
32 - 1 1/2"	pcs	1	AA765032064			
40 - 1"	pcs	1	AA765040010			
40 - 1 1/4"	pcs	1	AA765040054			
40 - 1 1/2"	pcs	1	AA765040064			
50 - 1"	pcs	1	AA765050010			
50 - 1 1/4"	pcs	1	AA765050054			
50 - 1 1/2"	pcs	1	AA765050064			
63 - 1 1/4"	pcs	1	AA765063054			
63 - 1 1/2"	pcs	1	AA765063064			
63 - 2"	pcs	1	AA765063020			

Insert transition PE - brass with nut SDR 11

For the system FV ENERGEO we deliver reliable electrofusion fittings Georg Fisher with integrated brackets to 63 mm diameter.

- Easy assembly with electro-fittings by Georg Fischer.



dimensions	unit	package	#			
25 - 3/4"	pcs	1	AA766025034			
32 - 1"	pcs	1	AA766032010			
40 - 1 1/4"	pcs	1	AA766040054			
50 - 1 1/2"	pcs	1	AA766050064			
63 - 1"	pcs	1	AA766063010			
63 - 1 1/2"	pcs	1	AA766063064			
63 - 2"	pcs	1	AA766063020			

Electrofusion Y-piece - reducing the number of branches

For the system FV ENERGEO we deliver reliable electrofusion fittings Georg Fisher with integrated brackets to 63 mm diameter.

- Easy assembly with electro-fittings by Georg Fischer.



dimensions	unit	package	#	d1 [mm]	d2 [mm]	length [mm]
32/32 - 40 direct	pcs	1	AA767003240	32	40	236
40/40 - 50 direct	pcs	1	AA767004050	40	50	255
32/32 - 40 90°	pcs	1	AA767103240	32	40	245
40/40 - 50 90°	pcs	1	AA767104050	40	50	270

PROBES

FV ENERGEO GH 12,5

Single-circuit vertical collectors designed to draw heat from geothermal boreholes to supply all types of soil/water heat pumps.

- d 40 x 3,7 and d 32 x 3,0 mm, l 50 - 150 m
- Robust head with fine factorywelding seam
- Full diameter in the whole profile of the collector
- Strong resistance to crack propagation
- More than 100 years of life



type	unit	weight [kg]	Ø of coil [m]	height of coil [mm]	#	D [mm]	length [m]
2 x 32 x 60	pcs	28	1,148	256	AA700123060	32	60
2 x 32 x 70	pcs	32	1,212	256	AA700123070	32	70
2 x 32 x 80	pcs	37	1,148	320	AA700123080	32	80
2 x 32 x 90	pcs	41	1,148	320	AA700123090	32	90
2 x 32 x 100	pcs	46	1,212	320	AA700123100	32	100
2 x 32 x 110	pcs	51	1,212	384	AA700123110	32	110
2 x 32 x 120	pcs	55	1,212	384	AA700123120	32	120
2 x 32 x 130	pcs	60	1,276	384	AA700123130	32	130
2 x 32 x 140	pcs	64	1,276	384	AA700123140	32	140
2 x 32 x 150	pcs	69	1,340	384	AA700123150	32	150
2 x 40 x 60	pcs	42	1,180	320	AA700124060	40	60
2 x 40 x 70	pcs	49	1,180	400	AA700124070	40	70
2 x 40 x 80	pcs	56	1,180	400	AA700124080	40	80
2 x 40 x 90	pcs	63	1,260	400	AA700124090	40	90
2 x 40 x 100	pcs	70	1,340	400	AA700124100	40	100
2 x 40 x 110	pcs	77	1,340	400	AA700124110	40	110
2 x 40 x 120	pcs	84	1,420	400	AA700124120	40	120
2 x 40 x 130	pcs	91	1,500	400	AA700124130	40	130
2 x 40 x 140	pcs	98	1,500	400	AA700124140	40	140
2 x 40 x 150	pcs	105	1,500	480	AA700124150	40	150

FV ENERGEO GH 16

Single-circuit vertical collectors designed to draw heat from geothermal boreholes to supply all types of soil/water heat pumps.

- d 40 x 3,7 and d 32 x 3,0 mm, l 130 - 220m
- Robust head with fine factorywelding seam
- Full diameter in the whole profile of the collector
- Strong resistance to crack propagation
- More than 100 years of life



type	unit	weight [kg]	Ø of coil [mm]	height of coil [mm]	#	D [mm]	length [m]
2 x 32 x 130	pcs	73	1276	384	AA700163130	32	130
2 x 32 x 140	pcs	78	1276	384	AA700163140	32	140
2 x 32 x 150	pcs	84	1340	384	AA700163150	32	150
2 x 32 x 160	pcs	90	1404	384	AA700163160	32	160
2 x 40 x 130	pcs	109	1500	400	AA700164130	40	130
2 x 40 x 140	pcs	118	1500	400	AA700164140	40	140
2 x 40 x 150	pcs	126	1500	480	AA700164150	40	150
2 x 40 x 160	pcs	134	1500	480	AA700164160	40	160
2 x 40 x 170	pcs	143	1580	480	AA700164170	40	170
2 x 40 x 180	pcs	151	1580	480	AA700164180	40	180
2 x 40 x 190	pcs	160	1660	480	AA700164190	40	190
2 x 40 x 200	pcs	168	1660	480	AA700164200	40	200
2 x 40 x 210	pcs	176	1580	560	AA700164210	40	210
2 x 40 x 220	pcs	185	1660	560	AA700164220	40	220

FV ENERGEO GH DUO 12,5

Double-circuit vertical collectors designed to draw heat from geothermal boreholes to supply all types of soil/water heat pumps.

- d 32 x 3,0 mm, l 60 - 130 m
- Robust head with fine factorywelding seam
- Full diameter in the whole profile of the collector
- Strong resistance to crack propagation
- More than 100 years of life



type	unit	weight [kg]	Ø of coil [mm]	height of coil [mm]	#	D [mm]	length [m]
4 x 32 x 60	pcs	55	1212	384	AA701123060	32	60
4 x 32 x 70	pcs	64	1276	384	AA701123070	32	70
4 x 32 x 80	pcs	74	1212	512	AA701123080	32	80
4 x 32 x 90	pcs	83	1276	512	AA701123090	32	90
4 x 32 x 100	pcs	92	1212	640	AA701123100	32	100
4 x 32 x 110	pcs	101	1276	640	AA701123110	32	110
4 x 32 x 120	pcs	110	1340	640	AA701123120	32	120
4 x 32 x 130	pcs	120	1340	640	AA701123130	32	130

FV ENERGEO GH DUO 16

Double-circuit vertical collectors designed to draw heat from geothermal boreholes to supply all types of soil/water heat pumps.

- d 32 x 3,0 mm, l 120 - 150 m
- Robust head with fine factorywelding seam
- Full diameter in the whole profile of the collector
- Strong resistance to crack propagation
- More than 100 years of life



typ	unit	weight [kg]	Ø of coil [mm]	height of coil [mm]	#	D [mm]	length [m]
4 x 32 x 120	pcs	134	1340	640	AA701163120	32	120
4 x 32 x 130	pcs	146	1340	640	AA701163130	32	130
4 x 32 x 140	pcs	157	1276	768	AA701163140	32	140
4 x 32 x 150	pcs	168	1340	768	AA701163150	32	150

PIPES FOR HORIZONTAL COLLECTOR

FV ENERGEO CP HDPE 100RC PN 10

High-quality HDPE RC pipes for construction of horizontal collectors of heat pumps ground/water. They are produced of the latest technology under permanent control of the top HDPE 100-RC polymer which ensures long-lasting perfect functionality of the system.

- High reliability and safety with life of over 100 years
- Low installation costs
- Increased resistance during handling
- Allows more difficult conditions when laying pipes
- Long-term pressure resistance even in case of mechanical damage



dimensions	unit	weight [kg]	Ø of coil [mm]	height of coil [mm]	#	D [mm]	length [m]
32 × 2,0 × 100	pcs	19	1150	192	AA710103100	32	100
32 × 2,0 × 150	pcs	29	1150	288	AA710103150	32	150
32 × 2,0 × 200	pcs	38	1150	384	AA710103200	32	200
40 × 2,4 × 100	pcs	28	1180	280	AA710104100	40	100
40 × 2,4 × 150	pcs	42	1180	440	AA710104150	40	150
40 × 2,4 × 200	pcs	56	1260	480	AA710104200	40	200

FV ENERGEO CP HDPE 100RC PN 12,5

High-quality HDPE RC pipes for construction of horizontal collectors of heat pumps ground/water. They are produced of the latest technology under permanent control of the top HDPE 100-RC polymer which ensures long-lasting perfect functionality of the system.

- High reliability and safety with life of over 100 years
- Low installation costs
- Increased resistance during handling
- Allows more difficult conditions when laying pipes
- Long-term pressure resistance even in case of mechanical damage



dimensions	unit	weight [kg]	Ø of coil [mm]	height of coil [mm]	#	D [mm]	length [m]
32 × 2,4 × 100	pcs	23	1150	192	AA710123100	32	100
32 × 2,4 × 150	pcs	35	1150	288	AA710123150	32	150
32 × 2,4 × 200	pcs	46	1150	384	AA710123200	32	200
40 × 3,0 × 100	pcs	35	1180	280	AA710124100	40	100
40 × 3,0 × 150	pcs	53	1180	440	AA710124150	40	150
40 × 3,0 × 200	pcs	70	1260	480	AA710124200	40	200

FV ENERGEO CP HDPE 100RC PN 16

High-quality HDPE RC pipes for construction of horizontal collectors of heat pumps ground/water. They are produced of the latest technology under permanent control of the top HDPE 100-RC polymer which ensures long-lasting perfect functionality of the system.

- High reliability and safety with life of over 100 years
- Low installation costs
- Increased resistance during handling
- Allows more difficult conditions when laying pipes
- Long-term pressure resistance even in case of mechanical damage



dimensions	unit	weight [kg]	Ø of coil [mm]	height of coil [mm]	#	D [mm]	length [m]
32 × 3,0 × 100	pcs	28	1150	192	AA710163100	32	100
32 × 3,0 × 150	pcs	42	1150	288	AA710163150	32	150
32 × 3,0 × 200	pcs	56	1150	384	AA710163200	32	200
40 × 3,7 × 100	pcs	42	1180	280	AA710164100	40	100
40 × 3,7 × 150	pcs	63	1180	440	AA710164150	40	150
40 × 3,7 × 200	pcs	84	1260	480	AA710164200	40	200

TOOLS

Electrofusion welder with barcode reader



	👤	📊	📦	#
SVEL 3500 - 3800W for d20-d300 mm	pcs	1	26,0	AA401102000
SVEL 3500 PLUS 3800W for d20-d300 mm with integrated list and direct printing welding Protocol	pcs	1	26,0	AA401104000

Weight

	👤	📊	📦	#
FV GS 32 13	pcs	1	13	AA709032013
FV GS 32 26	pcs	1	26	AA709032026
FV GS 40 13	pcs	1	13	AA709040013
FV GS 40 26	pcs	1	26	AA709040026

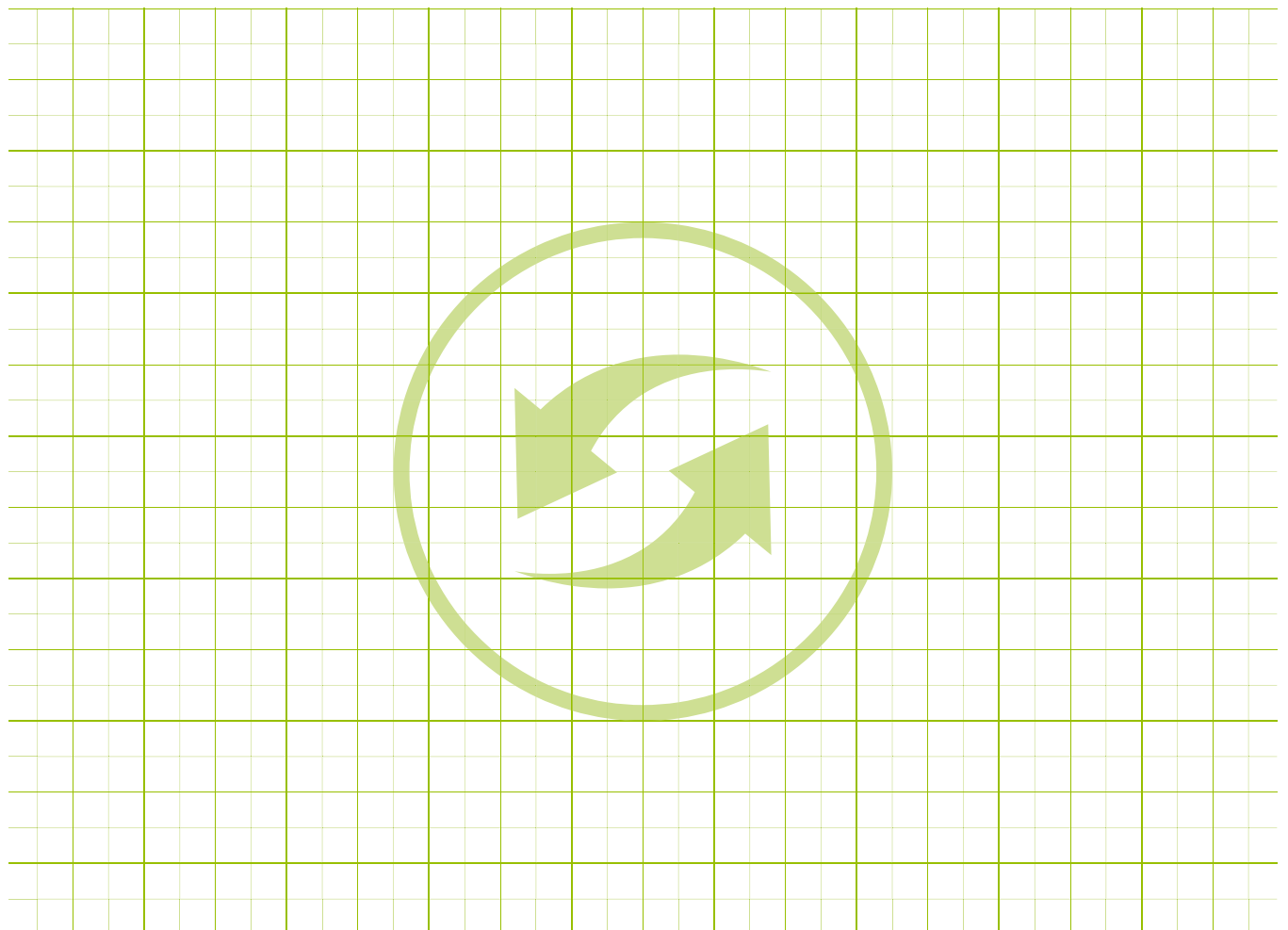

ASSEMBLY INSTRUCTION FOR FV ENERGEO

FV ENERGEO is a complete system of key elements for utilization of geothermal energy by means of depth wells and surface ground collectors. Geothermal energy is one of the most environmental-friendly and virtually inexhaustible heat resources and thus represents an attractive solution with an interesting returnability.

The installation design of the geothermal systems with heat pumps can be carried out exclusively by authorized persons and firms. Drilling of depth wells is addressed by specific legal codes for mining and in most countries it falls under the jurisdiction of the mining office.

SURFACE COLLECTORS

A system of ground surface collectors is the most effective option when considering the choice of the type of installation of a heat pump. Acquisition costs are comparable to the air-water system, the advantage being a higher effectivity (COP) and longer lifespan of the compressor.

In the case of surface collectors, the energy is obtained by means of piping laid horizontally below the ground, usually in a 1,2 - 1,5 m deep excavation, or alternatively in a groove dug by a trencher. For collectors, a piping of d32 to d40 is typically used, rarely also d25.

Antifreeze, a heat-carrying solution (e.g. Alcohol, Glycerine, Glycol) which is diluted by water to maintain its anti-freezing properties, flows through the pipeline system.

In the heat pump it passes its heat to the cooling agent, which then gains it back by its heating under the ground. The temperature of the ground in the depths up to 5 m is influenced by outside conditions (rain, snow, wind) and it also differs according to the season.

After the collectors are placed, it is not possible to carry out any other construction in this location. According to the bedrock, surface collectors must be constructed with a piping FV ENERGEO HDPE 100 RC in pressure lines PN10, PN12,5 and PN16. This material enables laying without sand bed and carrying out of backfill using directly the dug material including aggregate up to the size of 200 mm.

Bedrock	Specific consumption	
	at 1800 h	at 2400 h
Dry soil	10 W/m ²	8 W/m ²
Cohesive soil, wet	20-30 W/m ²	16-24 W/m ²
Watery sand / grit	40 W/m ²	32 W/m ²

CONNECTING

For connecting of individual pipes, mainly electro pipe fittings are used, rarely mechanical clamp links. When using the electro pipe fittings, a completely homogeneous link arises, therefore in the system FV ENERGEO we use high-quality electro pipe fittings Georg Fisher.

The work must be carried out by workers with welding license for plastic welding.

It is not possible to weld polyethylene with polypropylene, but at the same time we warn about mutual welding of pipes and pipe fittings from branched (LDPE, rPE) and linear polyethylene. Welding of these relatively hardly distinguishable materials (LDPE has thicker walls for the same pressure) cannot be by any means carried out in practice.

If it is necessary to connect these two materials, in case of any doubt about the origin of particular pipes, you are better advised to use mechanical clamp links.

BACKBONE PIPEAGE

Connection of a distributor / collector with thermal pumps is carried out by means of backbone pipeage. Backbone pipeage is made by a polyethylene piping of a higher diameter FV ENERGEO HDPE or FV ENERGEO HDPE-RC. The diameter of the piping is determined according to its length and a flow rate of the antifreeze liquid.

It is necessary to lay the backbone pipeage of the HDPE pipes in the sand bed.

INSULATION OF A PRIMARY CIRCUIT

All kinds of pipes, be it backbone pipeage or piping leading directly to the wells in the case of the surface collector, need to be insulated, beginning at 2 m away from the object. All pipes inside the object also need to be insulated, so as to avoid potential water condensation at the distributions.

It is only possible to insulate the primary circuit with a suitable rubber insulation, not with an insulation of the PE material and the like. It is necessary to protect the piping insulated by a rubber insulation outside the object by a cable duct and provide it with a gasket preventing the water intrusion into the gasket. Principles of correct installation of ground surface collectors:

- Right proportioning – the most important protection against freezing of the collector
- Drop pipe for easy bleeding at the highest point
- Compliance with safe pitches of piping – at least 60-100cm according to the piping diameter, optimally 1 m.
- Laying of collectors at least 0,7 - 1 m away from the water pipe / sewerage, in case of crossing with engineering networks insulating of the piping.

GEOHERMAL WELLS

In the case of geothermal wells the energy is obtained by means of geothermal ground probes. It is a closed system, where wells in the depth between 70 m and 300 m are machined by the piping FV ENERGEO HDPE-RC. At the end of the piping, there is a returnable U bend. Two basic ways of machining are used:

- One-circuit probes with pipes 2 x 25, 2 x 32 or 2 x 40 mm
- Two-circuit probes with pipes 4 x 32 mm.

The most common well depth is 150 m. The temperature at the depth of 20 m under ground is approximately 10 °C and rises by 1 °C for every 30 m – it is not influenced by momentary weather conditions or outside temperature at the surface, nevertheless it differs at the beginning and at the end of the season. At the depth of 150 m, there is virtually stable temperature of 15 °C, which is sufficient for the needful thermal gain. The higher thermal gain at greater depths is compensated by the significant growth of installation costs (well and machining). Antifreeze, a heat-carrying solution (e.g. Alcohol, Glycerine, Glycol) which is diluted by water to maintain its anti-freezing properties, flows through the pipeline system.

When proportioning the depth of the wells, we recommend expecting the profitability up to 50W/m for heating and up to the load of about 2400 hours yearly including the TUV heating. The profitability should be verified appropriately by a special test.

Bedrock	Specific consumption	
	at 1800 h	at 2400 h
Bad bedrock (dry sediment) - (λ . Normal solid rock and watery sediment - ($\lambda=1,5-3,0$ W/(m•K))	60 W/m	50 W/m
Solid rock with high thermal conductivity - ($\lambda>m\cdot3,0$ W/(m•K))	84 W/m	70 W/m
Individual rocks		
Dry sand, grit carrying water	65-80 W/m	55-65 W/m
In the case of a strong underground water-course in sand or grit, individual	80-100 W/m	80-100 W/m
Clay, soil, wet	35-50 W/m	30-40 W/m
Limestone massif	55-70 W/m	45-60 W/m
Sandstone	65-80 W/m	55-65 W/m
Acid magmatic rock (e.g. granite)	65-85 W/m	55-70 W/m
Basic magmatic rock (e.g. basalt)	40-65 W/m	35-55 W/m
Gneiss	70-85 W/m	60-70 W/m

Values may vary depending on the texture of rock (jointing, shale, weathering).

REDUCTION IN THE NUMBER OF BRANCHES (Y-PIECE)

Y-piece is a special pipe fitting for associating of two circuit geothermal ground probes in one circuit (32-32-40, or 40-40-50). By their use the number of connecting pipings leading from the well to the system of the distributor / collector and also the number of the outputs of the distributor / collector itself is reduced. Y-piece CANNOT be replaced by a classical T-piece because of the prevention of a strong pressure loss in the whole system! When using the reduction it is necessary to abide by an even division of the flow of the liquid into both loops of the geothermal well.

Principles of correct implementation of geothermal wells:

- Correct proportioning of the depth and the number of wells (wrong proportioning can lead to a freezing of the well)
- Compliance with safe distances between the geothermal wells according to the depth of the well – 10 % from the total well depth recommended
- Using of the FVENERGEOHDPE-RC probes
- Using services of verified drilling companies (a necessity of the implementation of the works with an approval of corresponding authorities)
- Compliance with basic conditions and not jeopardizing current systems of drilled / dug water wells in the vicinity (injecting of wells – isolation of particular water wells)

Before the project itself it is necessary to ascertain whether it is possible to drill at the estate, and to which depth. (in Nature Conservation Areas, areas of mining shafts, buffer zones of Prague underground)

LAYING OF A SAND BED

Laying in an open excavation, where sand is used for underlaying and surrounding of the piping, is one of the oldest ways of layings for PE piping. If we did not lay the older types of PE pipings (PE63, PE80 and PE100) which do not possess improved resistance to mechanical stress in sand, their expected lifespan would be reduced more than five times. Thanks to the sand underlaying and surrounding, which protects the piping, this method of laying is one of the laying methods with a low risk of damage.

LAYING

In the case of the piping from HDPE-RC, its laying and backfill can be carried out without the sand bed, using the directly excavated soil including the aggregate up to 200 mm.

In the case of HDPE pipings it is necessary to respect the character of the bedrock. If the piping route occurs in areas with soils of the minability class I. to IV. (according to ČSN736133:2010), we can also use the directly excavated soil for the laying. An exact determination of the minability class can only be determined by a geological research, that is usually a part of each project preparation. Earthwork during the piping laying must not influence its ovality. Material for surrounding and backfill need to be compactable enough. Piping is laid onto the even and paved bottom of a groove. The surrounding is carried out layer by layer and is compacted.

If the route of the piping is located in areas with soils of the minability classes of V. to VII. or where the occurrence of these soils cannot be disproved, it is necessary to duly lay the piping in a sand bed.

CONNECTING

For connecting of individual pipings, mainly electro pipe fittings, and rarely mechanical clamp links are used. When electro pipe fittings are used, a completely homogenous link arises, therefore in the FV ENERGEO system we use high-quality electro pipe fittings Georg Fisher.

WELDING

For connecting the FV ENERGEO HDPE and HDPE-RC pipes with pipe fittings or butt welding can be used, polyfusion or with the use of electro pipe fittings which we recommend for the FV ENERGEO system. Apart from a problem-free connecting right in the field, electro pipe fittings also enable assembling of the whole piping thanks to integrated clamps.

Welding work must be carried out by workers with welding licence for plastic welding.

It is unacceptable to weld polyethylene with polypropylene and to weld pipings

and pipe fittings of branched (LDPE, rPE) and linear (HDPE, HDPE-RC) polyethylene. If it is necessary to connect these two materials, mechanical clamp links must be used.

The most important operations for achieving a high-quality weld are:

- cleansing of the ends of the pipes or pipe fittings of mechanical dirt
- perpendicular trimming (planing) of the ends of the pipes, so that the maximum distance between the contacted pipes is 0,5 mm.
- check of mutual overrunning of the pipings which must not exceed 1/10 of the wall thickness (be careful about pipings from different pressure lines!)
- in the case of polyfusion and electro welding removing of an oxidizable layer of plastic with subsequent cleansing with a suitable degreasing and cleansing agent. Cleansing is carried out immediately before welding and cleansed surfaces must not be contaminated by a touch of a hand.
- A place of butt welding or polyfusion welding should be protected against weather conditions.

Be careful about welding at low temperatures – allowed minimum temperatures at which welding is still possible, are determined by the properties of welding machines or electro pipe fittings. In the strong wind, in the case of butt welding or polyfusion welding, it is necessary to check not only the right temperature settings of the welding agents, but also the actual agent temperature.

Welding temperature for PE butt welding is 200–220 °C, for polyfusion welding 250–270 °C. It is important to comply with the time course of particular operations including the time for weld cooling, during which the weld cannot be burdened mechanically. In this context we refer to the instructions of the manufacturers of particular welding devices and primarily to the compulsory trainings.

MECHANICAL CONNECTING

Mechanical clamp links enable connecting of combinations of different materials and also enable the use of slightly oval pipings which can be formed by pipe fittings. Links can be metal or plastic. When carried out properly, the link has the same or higher breaking strain than the connected piping itself. Connecting using flanges (edge bearers).

MANIPULATION WITH THE PIPING, MECHANICAL STRAIN AND CHANGE IN THE DIRECTION OF THE PIPING (BENDING)

It is not allowed to carry out heat shaping of the pipes at the construction site. However, PE elasticity allows for a change of direction or copying the terrain by producing arcs with a diameter R, which should be, according to the temperature (independently of the piping pressure line):

- 20 °C.....20 x D
- 10 °C.....35 x D
- 0 °C.....50 x D

where D is the outer piping diameter. A properly carried out excavation can therefore mean savings of the material and time.

For more significant changes in the direction, particular pipe fittings need to be used.

Spools with pipings must be protected against mechanical damage. In a case of visible damage of the outer layer (its cutting or rubbing) it is necessary to cut out the particular piping and connect the ends with a suitable pipe fitting.

Pipes can only be unwinded the opposite way than they have been wound during their production. Spiral unwinding, when the wall of the piping is strained torsionally and when there is a danger of „breaking“ the piping, is strictly forbidden.

Fittings and cast iron pipe fittings need to be built in in such a way that their own mass or forces needed for their operation would not produce forces that were not taken into account when designing. We recommend fixing the fittings by a „firm point“, e.g. using a concrete block and so on.



FV INFRA PIPES

FV HDPE 100 SDR11

System: **FV INFRA**
 Material: HDPE
 Standard: ČSN EN 12201-2
 Details: Length 12 m on request

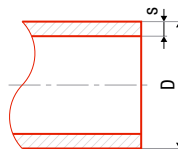

DN	⊕	⊞	⊞	⊞	⊞	#	D [mm]	s [mm]	SDR	l [m]	
25 × 2,3	m				0,17	0,73	AA160025100	25	2,3	11	100
32 × 3,0	m				0,27	1,10	AA160032100	32	3,0	11	100
40 × 3,7	m				0,43	1,83	AA160040100	40	3,7	11	100
50 × 4,6	m				0,67	2,75	AA160050100	50	4,6	11	100
63 × 5,8	m				1,05	4,07	AA160063100	63	5,8	11	100
25 × 2,3	m				0,17	0,73	AA160025006	25	2,3	11	6
32 × 3,0	m				0,27	1,10	AA160032006	32	3,0	11	6
40 × 3,7	m				0,43	1,83	AA160040006	40	3,7	11	6
50 × 4,6	m				0,67	2,75	AA160050006	50	4,6	11	6
63 × 5,8	m				1,05	4,07	AA160063006	63	5,8	11	6

FV HDPE 100 SDR17

System: **FV INFRA**
 Material: HDPE
 Standard: ČSN EN 12201-2
 Details: Length 12 m on request

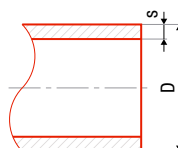

DN	⊕	⊞	⊞	⊞	⊞	#	D [mm]	s [mm]	SDR	l [m]	
32 × 2,0	m				0,19	1,10	AA161032100	32	2,0	17	100
40 × 2,4	m				0,30	1,83	AA161040100	40	2,4	17	100
50 × 3,0	m				0,45	2,75	AA161050100	50	3,0	17	100
63 × 3,8	m				0,72	4,07	AA161063100	63	3,8	17	100
32 × 2,0	m				0,19	1,10	AA161032006	32	2,0	17	6
40 × 2,4	m				0,30	1,83	AA161040006	40	2,4	17	6
50 × 3,0	m				0,45	2,75	AA161050006	50	3,0	17	6
63 × 3,8	m				0,72	4,07	AA161063006	63	3,8	17	6

FV HDPE 100 RC SDR 11

System: **FV INFRA**
 Material: HDPE
 Standard: ČSN EN 12201-2
 Details: Length 12 m on request

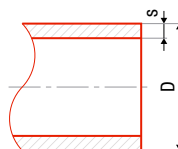

DN	⊕	⊞	⊞	⊞	⊞	#	D [mm]	s [mm]	SDR	l [m]	
25 × 2,3	m				0,17	0,73	AA162025100	25	2,3	11	100
32 × 3,0	m				0,27	1,10	AA162032100	32	3,0	11	100
40 × 3,7	m				0,43	1,83	AA162040100	40	3,7	11	100
50 × 4,6	m				0,67	2,75	AA162050100	50	4,6	11	100
63 × 5,8	m				1,05	4,07	AA162063100	63	5,8	11	100
25 × 2,3	m				0,17	0,73	AA162025006	25	2,3	11	6
32 × 3,0	m				0,27	1,10	AA162032006	32	3,0	11	6
40 × 3,7	m				0,43	1,83	AA162040006	40	3,7	11	6
50 × 4,6	m				0,67	2,75	AA162050006	50	4,6	11	6
63 × 5,8	m				1,05	4,07	AA162063006	63	5,8	11	6

FV HDPE 100 RC SDR 17

System: **FV INFRA**
 Material: HDPE
 Standard: ČSN EN 12201-2
 Details: Length 12 m on request

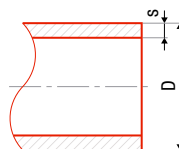

Size	Material	Weight	Volume	Length	Code	D [mm]	s [mm]	SDR	l [m]
32 × 2,0	m	0,19	1,10	AA163032100	32	2,0	17	100	
40 × 2,4	m	0,30	1,83	AA163040100	40	2,4	17	100	
50 × 3,0	m	0,45	2,75	AA163050100	50	3,0	17	100	
63 × 3,8	m	0,72	4,07	AA163063100	63	3,8	17	100	
32 × 2,0	m	0,19	1,10	AA163032006	32	2,0	17	6	
40 × 2,4	m	0,30	1,83	AA163040006	40	2,4	17	6	
50 × 3,0	m	0,45	2,75	AA163050006	50	3,0	17	6	
63 × 3,8	m	0,72	4,07	AA163063006	63	3,8	17	6	

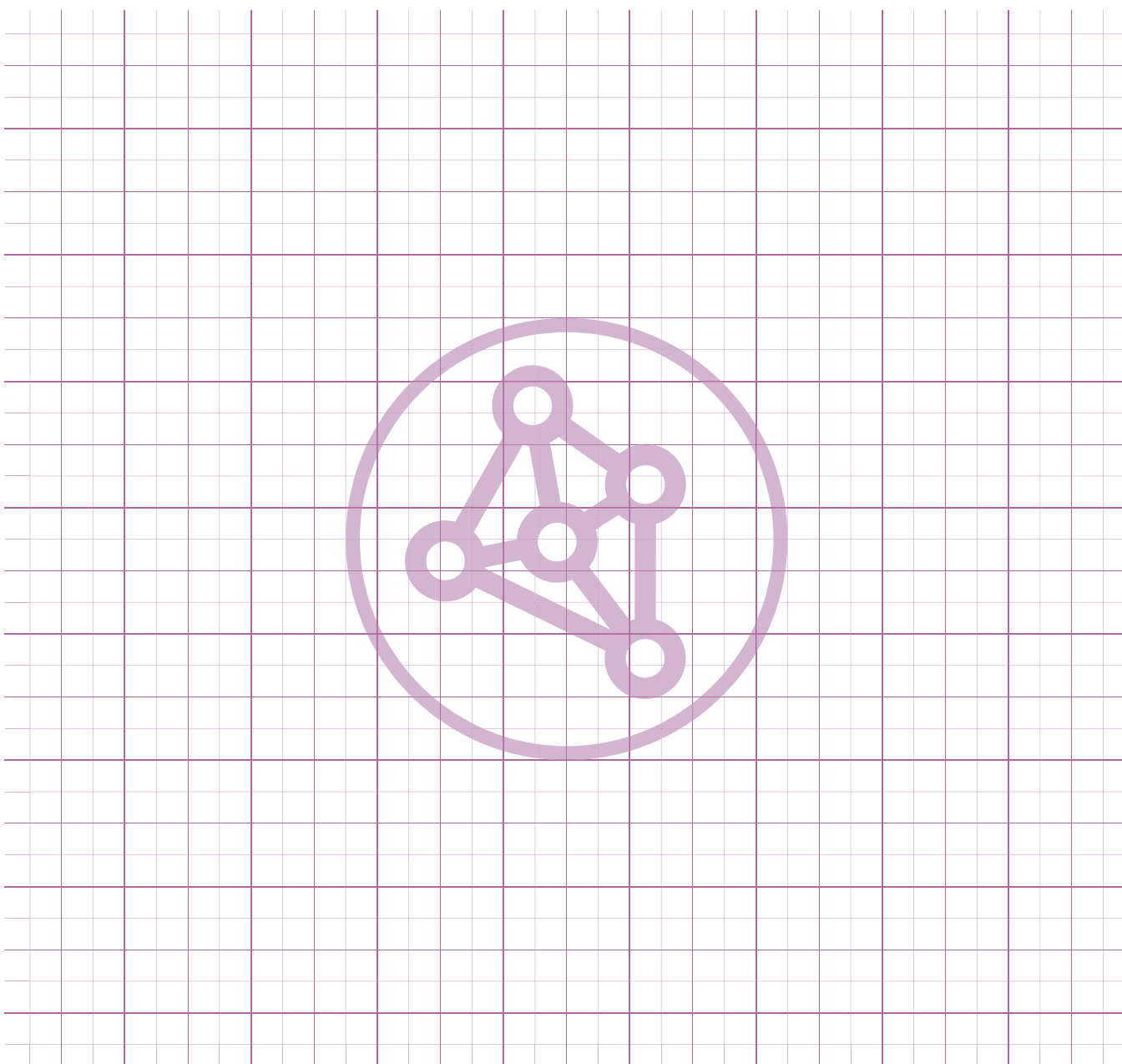

ASSEMBLY INSTRUCTION FOR FV INFRA

FV HDPE 100 and HDPE 100 RC pipes (resistant to cut) are used mainly for infrastructural water distribution. They are made from high-density polyethylene (HDPE, PEHD or I-PE).

HDPE 100 MRS firmness is 10 MPa – 2,5 times higher than up to now common used low-density polyethylene (LDPE). The wall thickness and hydraulic parameters of the stated pressure decreased considerably. HDPE 100 is more resistant to damage and chemicals and has better characteristics.

HDPE 100 RC pipes are more resistant to cut and damage by point load and are suitable for extreme conditions layout.

FV HDPE PIPING USE

FV HDPE 100 and FV HDPE 100 RC pressure pipes can be used for:

- the distribution of drinking and non-potable water
- the distribution of common cooling and non-freezing mixtures
- the distribution of some water suspension
- the distribution of some chemicals
- the distribution of air and other gases
- the hydro distribution of abrasive materials
- primary circuits and thermal pump exchangers
- snowmaking devices (snow cannons)
- the construction of pressure and vacuum canalization systems

Liquid and loose materials can be distributed if the risk of electrostatic charge is not imminent. HDPE piping is resistant to the common chemicals, the distribution of drinking water from organic matter highly contaminated soil is not recommended.

LAYOUT

Layout method	FV HDPE 100	FV HDPE 100 RC
“Sand“ trench layout	no risk	no risk
Trench layout, grain to 200mm	unsuitable	moderate risk
Relining smooth inner surface pipe	no risk	no risk
Relining pipe unspecified inside	unsuitable	moderate risk
Plowing	unsuitable	moderate risk
Milling	unsuitable	moderate risk
Controlled underdrilling*	unsuitable	moderate risk

ČSN EN 805 requirements regarding construction, lines and safety belt spacing need to be followed when placing the layout.

The drinking water distribution pipes are placed into non-frozen depth as per ČSN 73 6005:

- On the sidewalk and free terrain outside built-up area between 1,00 - 1,60 m (regarding the type and character of soil).
- On the road minimum of 1,5 m.

Taking measures against water piping freezing using an insulation or heating is required in case of shallow mounting.

Piping anchoring is needed in case of a lengthwise slant over 15 % depending on geological ratio.

Piping length dilatations are not necessary to deal with in case of soil mounting. Dilatation compensations are required in case of piping layout above ground and in buildings because of a high thermal expansivity coefficient (0,2 mm/m.K).

Piping trench and mounting is important. The trench width has to enable safe pipe manipulation including its connection and sufficient soil compaction in the pipe surroundings.

The trench width depends on piping diameter and required trench depth.

TRENCH MINIMAL WIDTH AS PER PIPING DIAMETER:

d [mm]	Trench minimal width D + x [m]		
	supported trench	non-supportive trench	
		$\beta > 60^\circ$	$\beta \leq 60^\circ$
≤ 225	D + 0,40	D + 0,40	D + 0,40
$> 225 \leq 350$	D + 0,50	D + 0,50	D + 0,40
$> 350 \leq 700$	D + 0,70	D + 0,70	D + 0,40

d – pipe outer diameter [mm], D – pipe outer diameter [m], β – non-supported trench wall angle. The lowest working spacing between pipe wall and (supported) trench wall is $x / 2$.

TRENCH MINIMAL WIDTH AS PER TRENCH DEPTH:

Grove depth [m]	Minimal width [m]
$> 1,00$	not prescribed
$\geq 1,00 \leq 1,75$	0,80
$> 1,75 \leq 4,00$	0,90
$> 4,00$	1,00

The soil under the pipe and to 15 cm above pipe upper margin is considered effective (see schematic sectional views of mounting). Embankment and compaction is made layer after layer, always on pipe's both sides. The pipes of 110 mm diameter or higher are compacted manually or using soft-compacting machinery. Compaction is not used directly above the pipe to the height of 30 cm. When compacting, the pipes cannot be moved vertically or horizontally.

PE 100RC pipes can be used for so called “non-sand layout” for most common trenches and covered by dig material to 50 % of aggregate additives of the size to 250 mm.

The PE100 pipes are placed into the trench on sand or sandy gravel base of minimal thickness of $L = 10$ cm. The soil does not need to be compacted, although it cannot be too loosen. The effective layer gritting is made by sand or soil without sharp-edged parts for the HDPE 100 piping and pipe fittings.

The pipes cannot be placed on the frozen soil. The entire pipes have to lay on the terrain, without point contact with the rock - assembly holes are created in case of the mechanical pipe fittings or the electrofusion pipe fittings. Mounting angle should be larger than 90° .

The new sand or sandy gravel base has to be created for the pipes (excluding RC pipes) in rock or stone bedrock after removing approximately 15 cm layer.

For pipe fittings gritting, the sand is used for each type of piping if not stated differently. The gritting should exceed the pipe fitting by 20 cm minimum on each side.

The pipes CANNOT be placed directly on concrete or other hard surfaces. If the concrete sheets are used in soils of low-bearing capacity, the 15 cm sand or sandy gravel base has to be created.

PIPING GRITTING AND BACKFILL

The soil corresponding with the specification for the effective layer and given type of piping is used. Hollows cannot emerge in the pipe surroundings, thus, materials that can change their volume or consistency cannot be used for backfill.

Water pipes cannot go through the soil contaminated by organic material. This soil cannot be used for gritting. The unsuitable soil has to be replaced with suitable soil.

A warning foil marking the pipes it recommended as per ČSN 73 6006 (8/2003). The foil should be placed above the pipe top in 20 cm minimum.

The material and compaction method corresponding to the use of given area is used for the pipes upper backfill. It is possible to compact above the pipe from 30 cm covering.

FV HDPE 100 pipes mounting scheme in the trench

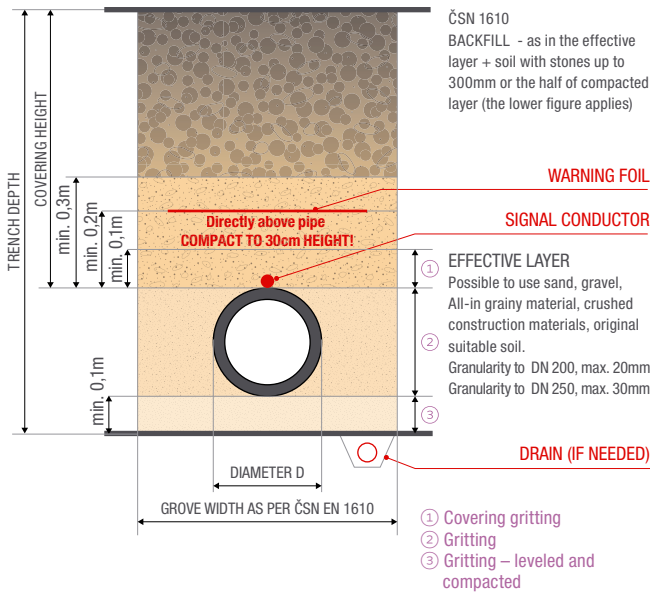

FV HDPE 100 RC pipes mounting scheme in the trench

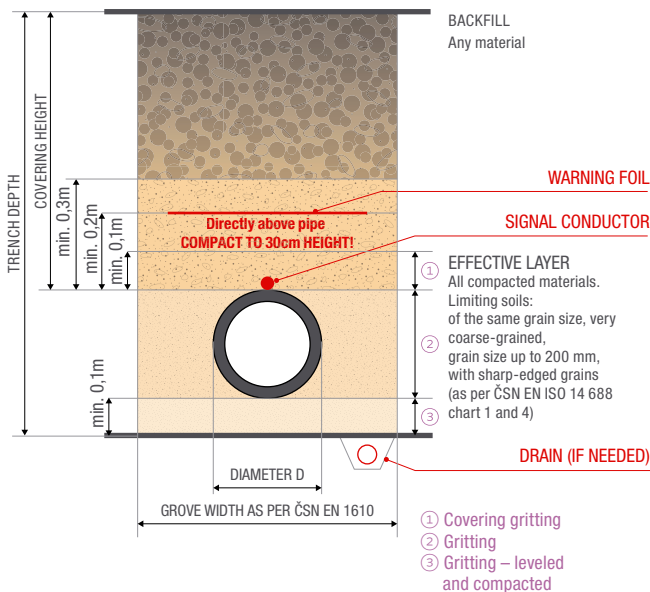

CONNECTION

PE pipes and pipe fittings are connected by welding or mechanically.

POLYETHYLENE PIPES PASTING IS NOT ALLOWED!

Couplers can be combined with different SDR and materials. The couplers are metal or plastic. The proper connection installation has the same or higher pulling firmness than the connected pipes.

Follow the pipe fittings producer's instructions when connecting. The components have to be clean. Mark the insertion depth (using a marker or a pencil) for the correct connection.

WELDING

The HDPE pipes and pipe fittings can be blunt welded or welded by means of electrofusion fitting, occasionally polyfusion welded.

The HDPE100 and HDPE 100 RC pipes and pipe fittings welding is not restricted. It is not possible to weld polyethylene and polypropylene.

Also, it is not possible to weld HDPE, IPE, PE80, PE100 and LDPE, rPE, PE40 polyethylene pipes or pipe fittings. HDPE and LDPE non-welded pipes can be connected by mechanical couplers only.

PIPES BENDING/ PIPING DIRECTION CHANGES

The corresponding pipe fittings are used to change the direction. Shaping the pipes on a construction site using heat is not allowed. HDPE flexibility enables the changing the direction or copying the terrain by making bents in the ratio R. The bent ratio depends on the diameter of the pipe and on temperature, it does not depend on pipe's pressure class.

ALLOWED BENT RATIOS

Temperature	20 °C	10 °C	0 °C
Bent ratio R	20 × D	35 × D	50 × D
D is the outer diameter of pipe			

The usage of pipe fittings and pipes can be lowered by suitable bent implementation when performing trench works.

DISTRIBUTION, STORAGE AND MANIPULATION

- The entire pipes have to be placed on the base when distributed and stored. Underlaid beams should not be narrower than 50mm.
- Pipes placed in rods cannot be bent on edges. Pipe endings exceeding the vehicle loading area by more than 1m need to be supported.
- Pipes cannot be moved on sharp gravel or base.
- Maximal pipes storage height is 1,6 m, side support spacing should not exceed 3 m.
- Longer pipes storage under direct sunlight can lead to the change of color.
- HDPE piping can be stored and manipulated with also in the winter (the temperature should not exceed - 20 °C).
- Products have to be protected against the contact with solvents and toxic materials contamination.
- Pipes and pipe fittings safety covers can be removed closely to their use.
- Folded pipes are stored vertically, secured against fall, or horizontally up to 1,6 m height.
- Before unpacking the pipes, remove the tape securing the outer pipe end and loosen gradually following layers. We recommend loosening only the amount of piping needed.
- Unfolding device (cart) is recommended for unfolding the pipes, it is possible to use a slow-moving vehicle.
- Unfolding the pipe in spiral is not allowed – pipe can break.
- When unfolding or straightening, the pipes cannot be strained by excessive bending, especially when the temperature is low.
- We recommend adding straightening devices to the unfolding cart.

ALLOWED PIPE DAMAGE WHEN USING FOR PRESSURE APPLICATIONS

The maximal pipe wall damage depth:

- FV HDPE 100** - allowed gritting only: max. 10 % of wall thickness
- FV HDPE 100 RC** - sand gritting: max. 15 % of wall thickness
- FV HDPE 100 RC** - different gritting: max. 10 %

INDEX

FV PP-RCT UNI	14	FV PPR union plastic / brass unwelded	32
FV PP-RCT FASER COOL	14	FV PPR plastic reducing sleeve with cap nut	33
FV PP-RCT HOT	15	FV PPR coupling with nut.....	33
FV PP-RCT FASER HOT.....	15	FV PPR elbow 90° plastic reducing sleeve with cap nut.....	33
FV PP-RCT STABIOXY	15	FV PPR tee plastic reducing sleeve with cap nut.....	33
FV PPR CLASSIC S2,5 SDR6 (PN 20) 4m.....	16	FV PPR flange adaptor	34
FV PPR CLASSIC S2,5 SDR6 (PN 20) 3m.....	16	FV PPR FE flange	34
FV PPR CLASSIC - PIPE IN COIL.....	17	FV PPR transition union male	34
FV PPR FASER S2,5 SDR6 (PN 20) 4m.....	18	FV PPR transition union female.....	34
FV PPR FASER S2,5 SDR6 (PN 20) 3m.....	18	FV PPR elbow 90° for wall mounting.....	35
FV PPR compensation pipe.....	22	FV PPR elbow 90° for wall mounting intenal / external	35
FV PPR crossover.....	22	FV PPR wall mounting elbow with metal female thread LEFT and RIGHT	35
FV PPR crossover with socket.....	22	FV PPR elbow with metal female thread UNI.....	35
FV PPR crossover with socket short.....	22	FV PPR holder MONO for UNI elbow.....	35
FV PPR elbow 90°.....	23	FV PPR DUO for UNI elbow	36
FV PPR elbow 90° reduced.....	23	FV PPR wall elbows with holder	36
FV PPR elbow 45°.....	23	FV PPR elbow for gypsum wall mounting.....	36
FV PPR elbow 90° internal / external	23	FV PPR tee with tap connector.....	36
FV PPR elbow 45° internal / external	24	FV PPR wall mounting group with tap connectors.....	36
FV PPR elbow 90° for wall mounting welding	24	FV PPR assembling plate for elbow 90° for wall mounting	37
FV PPR reduction internal / external.....	24	FV PPR electro-fusion socket.....	37
FV PPR three-way elbow	24	FV PPR joining elbow 45° to the radiator.....	37
FV PPR socket	25	FV PPR joining elbow 90° to the radiator.....	37
FV PPR reduction	25	FV PPR sleeve euroconus with metal thread.....	37
FV PPR bend 90° internal / external	25	FV PPR ball valve plastic with a butterfly.....	38
FV PPR bend 90°	25	FV PPR ball valve plastic with a lever	38
FV PPR tee.....	26	FV PPR radiator ball valve straight	38
FV PPR tee reduced	26	FV PPR radiator ball valve elbow	38
FV PPR cross piece	26	FV PPR FV PPR ball valve plastic with PV valve	38
FV PPR reducing sleeve with plastic male thread.....	27	FV PPR ball valve with threaded elbow for hose connection	39
FV PPR tap elbow for welding internal.....	27	FV PPR valve with threaded elbow for hose connection	39
FV PPR threaded tap connector (fast)	27	FV PPR straight-way valve	39
FV PPR blinding.....	27	FV PPR straight-way valve with PV valve	39
FV PPR threaded tap connector	28	FV PPR angle straight-way valve.....	40
FV PPR blinding internal	28	FV PPR angle straight-way valve with PV valve.....	40
FV PPR pressure plug short.....	28	FV PPR angle straight-way valve with back flow	40
FV PPR all plastic weld in saddle.....	28	FV PPR back flow valve	40
FV PPR washer	29	FV PPR filter.....	41
FV PPR pressure plug long	29	FV PPR shut off valve lux straight with chrome handle.....	41
FV PPR elbow 90° with metal male thread.....	30	FV PPR shut off valve straight with cover	41
FV PPR reducing sleeve with metal male thread	30	FV PPR inside the valve.....	41
FV PPR reducing sleeve with metal female thread	30	FV PP-RCT butt welding elbow 90°	42
FV PPR elbow 90° with metal female thread	31	FV PP-RCT butt welding elbow 45°	42
FV PPR weld in saddle with metal male thread	31	FV PP-RCT butt welding reduction.....	42
FV PPR weld in saddle with metal female thread	31	FV PP-RCT electro-fusion socket.....	42
FV PPR reducing sleeve with metal female thread with cross	31	FV PP-RCT butt welding tee	43
FV PPR tee with metal female thread.....	32	FV PP-RCT polyfusion/butt welding tee reduced	43
FV PPR tee with metal male thread.....	32	FV PP-RCT butt welding blinding	43
FV PPR metal reducer with cap nut.....	32	FV PP-RCT weld in saddle polyfusion.....	43
		FV PP-RCT weld in saddle with metal male thread polyfusion	44

FV PP-RCT weld in saddle with metal female thread polyfusion	44	FV M-PRESS tee with metal male thread	72
FV PP-RCT butt welding flange adaptor	44	FV M-PRESS shut off ball valve lux straight with chrome handle	72
FV PP-RCT flange	44	FV M-PRESS shut off ball valve straight with cover	73
Welding machine 650W for non-paired adapter Ø16-Ø63	48	FV M-PRESS joining elbow 90° to the radiator	73
Welding machine 850W for paired adapter Ø16-Ø75	48	FV M-PRESS reducing sleeve to Cu	73
Dytron Welder Polys P-4 650W	48	FV M-PRESS blinding	73
Dytron Welder Polys P-4 850W	48	FV P-PRESS reducing sleeve with metal male thread	74
Dytron Welder Polys P-4 1200W	48	FV P-PRESS reducing sleeve with metal female thread	74
Dytron Welder Polys P-1b 500W	49	FV P-PRESS reducer with cap nut	74
Mini set SM 21	49	FV P-PRESS join	75
Mini set SM 41	49	FV P-PRESS reduction	75
Profi set SE 21	49	FV P-PRESS elbow 90°	75
Profi set SE 41	49	FV P-PRESS blinding	75
Adapter paired for SM 41 and SE 41 black	50	FV P-PRESS tee	76
Adapter paired for SM 41 and SE 41 blue	50	FV P-PRESS tee reduced	76
Adapter paired for weld in saddle	50	FV P-PRESS manifold 4 circuits	76
Drill for weld in saddle	51	FV P-PRESS manifold 5 circuits	77
Adapter non-paired for SM 21 and SE 21 black	51	FV P-PRESS manifold 6 circuits	77
Adapter non-paired for SM 21 and SE 21 blue	51	Calibrator for FV MULTIPIPES metal	78
Repairing set	51	Calibrator for FV MULTIPIPES metal	78
Repairing stake	51	Calibrator for FV MULTIPIPES plastic	78
STABIOXY pipes shaver	52	Calibrator for FV MULTIPIPES plastic with shaver	78
Shavers to drill machine for STABIOXY pipes	52	Bending pipe outer for FV MULTIPIPES	78
Cordless pipe shears d40	52	Bending pipe spring inner for FV MULTIPIPES	79
Pipe cutter REMS	52	REMS pressing jaws BASIC E 01	79
Shears	53	REMS pressing jaws Mini BASIC E 01	79
Tightening spanner with belt	53	TC inserts into universal pressing jaws for fittings FV P-PRESS	79
Spiral for sewer cleaning	53	Pipe insulation Tubex (foamed PE)	82
Assembly MP 75	53	Adhesive insulation tape	82
Assembly MP 110 UD	53	Adhesive tape	82
Spider 125 with universal clamping	54	Insulation clip	83
Spider Demo stand	54	Insulation felt	83
Case for welding machine type PROFI	54	O-ring Taboren	83
Case for welding machine type MINI	54	Teflon insulation tape	83
FV MULTIPERT-AL pipe in coil	64	Plastic clip PP	84
FV MULTIPERT-AL pipe in stick	64	Plastic double clip PP	84
FV M-PRESS reducer with cap nut	66	Plastic clip with stirrup	84
FV M-PRESS reducing sleeve with metal female thread	66	Plastic double clip with stirrup	84
FV M-PRESS reducing sleeve with metal male thread	67	Spacing clip for cold water	85
FV M-PRESS join	67	Plastic clip with strap	85
FV M-PRESS reduction	68	Metal sleeve	85
FV M-PRESS elbow 90°	68	Screw combi	85
FV M-PRESS elbow 45°	68	Dowels	86
FV M-PRESS elbow 90° for wall mounting	69	Threaded bar	86
FV M-PRESS running elbow 90° for wall mounting	69	Clamping strap	86
FV M-PRESS running elbow 180° for wall mounting	69	Plastic trough	86
FV M-PRESS elbow 90° with metal female thread	69	Trough cover plastic	86
FV M-PRESS elbow 90° with metal male thread	70	Galvanized trough (2 m length)	87
FV M-PRESS elbow 90° reducing sleeve with cap nut	70	RPE pipe	87
FV M-PRESS wall mounting group with tap connectors for gypsum walls	70		
FV M-PRESS wall mounting group with tap connectors	70		
FV M-PRESS tee	71		
FV M-PRESS tee reduced	71		
FV M-PRESS tee with metal female thread	72		

FV MULTIPERT-5	90	Plastic segment manifold FV PUSH, 1-4 l/min	114
FV MULTIPEX-5	90	Plastic segment manifold FV PUSH, 2-8 l/min	114
FV MULTIPERT-AL	90	FV spherical valve for dividers 1"-6/4"	115
FV EPS insulated mounting mate in roll	91	FV T - transitional quick coupling	115
FV NOP UNI system mat	91	FV direct quick coupling	115
FV NOP SOLO system mat	91	FV angular tube - quick coupling	115
FV NOP ISO system mat with 11 mm insulation	91	FV transition	115
FV NOP ISO PLUS system mat with 30 mm insulation	92	FV blinder (sealing) unit	116
FV TBS system mat with 25 mm for dry construction	92	FV relieving case	116
FV TBS L guide plate	92	FV actuator NC-24V	116
FV TBS C reversing arc for mats FV TBS	92	FV KLIMA manual areal thermostat	116
FV RENO special mat for floor reconstruction	92	FV condensation point receptor	117
FV clamping rail	93	FV condensation point receptor for plasterboard	117
FV staple for clamping rail	93	FV condensation point convertor	117
FV manifold with flowmeter	93	FV bus UZR 24 - 4	117
FV manifold INOX	94	FV extending bus module URM 24 - 2	117
FV manifold with flowmeter plastic	94	Clamping bar PENTA Ø14/15/16/17/18	118
FV mixing set for 200 m ²	95	Clamping bar R 25 for pipe 8 x 1	118
FV mixing set for 160 m ²	95	Arc console for clamping bar R 25	118
FV ball valve 1" with male and female tread	95	FV silicone paste for sealing O-circlets	118
FV thermometer for manifold	95		
FV manifold cabinet on plaster	96	NEW BRADO	122
FV manifold cabinet under plaster	96	ALTRA SCANDIC	122
FV tacker staple	96	SPIDER	123
FV edge belt	96	GIGA	123
FV PE protecting tube	97	NOMO	124
FV dilatation belt	97	REGA	124
FV direction diverter	97	REGO	124
FV direction diverter "click"	97	Electrofusion socket SDR 11	125
FV fixing plastic bend	97	Electrofusion blinding SDR 11	125
FV self-adhesive tape	98	Electrofusion reduction of SDR 11	125
FV screed plasticizer	98	Electrofusion bend 90° SDR 11	126
FV servodrives	98	Insert transition PE - brass female thread SDR 11	126
FV thermostatic controller	98	Insert transition PE - brass male thread SDR 11	126
FV electronic switching module	98	Insert transition PE - brass with nut SDR 11	127
FV transformer 230/24 V	99	Electrofusion Y-piece - reducing the number of branches	127
FV flowmeters	99	FV ENERGEO GH 12,5	127
FV transition union to the distributor (Eurocone 3/4")	99	FV ENERGEO GH 16	128
FV coupling	100	FV ENERGEO GH DUO 12,5	128
FV reducing sleeve male 3/4"	100	FV ENERGEO GH DUO 16	128
FV plug female 3/4"	100	FV ENERGEO CP HDPE 100RC PN 10	129
FV Tacker - fixing gun	100	FV ENERGEO CP HDPE 100RC PN 12,5	129
FV Tacker - fixing gun plastic	101	FV ENERGEO CP HDPE 100RC PN 16	129
FV horizontal decoiler	101	Electrofusion welder with barcode reader	130
		Weight	130
FV COOLING PE-RT 16 x 2 mm	112		
FV COOLING PB 8 x 1 mm	112	FV HDPE 100 SDR11	134
FV cooling matting CoolIFLEX	112	FV HDPE 100 SDR17	134
FV cooling plasterboard panel CoolPLATE	113	FV HDPE 100 RC SDR 11	134
Plasterboard Thermalpanel FV KLIMA dpt. 10 mm	113	FV HDPE 100 RC SDR 17	135
Plastic segment manifold FV PUSH 16, 0,6-2,4 l/min	113		





FV - Plast, a.s.

Kozovazská 1049/3

250 88 Čelákovice

Czech Republic

T: +420 326 706 711

F: +420 326 706 721

@: fv-plast@fv-plast.cz

WWW.FV-PLAST.CZ